

1. Introduction: The Prosodic Tier

The structure of the CV tier and its formal descendents has been a matter of much debate in phonological theory. The original CV tier proposed by McCarthy (1979) has been retained to the present by some researchers, but has also been challenged by other theories of prosodic tier structure. Levin (1985) and Lowenstamm and Kaye (1986) have proposed to replace the symbols C and V with a uniform sequence of elements, represented here as Xs. The elements of this "X tier" are distinguished from each other by their organization into a fairly rich syllable structure, which includes a nucleus node:

(1) a. CV Theory



b. X Theory

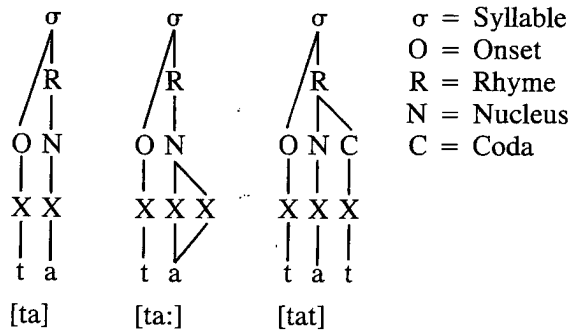

Many people have provided me with helpful comments on earlier versions of this work. In particular, I would like to thank G. N. Clements, A. Cohn, M. Hammond, H. Hock, L. Hyman, P. Keating, M. Kenstowicz, A. Lahiri, I. Lehiste, B. Levergood, J. McCarthy, A. Mester, K. Michelson, D. Minkova, D. Perlmutter, A. Prince, D. Steriade, L. Wetzels, and two anonymous reviewers for *Linguistic Inquiry*.

Both CV theory and X theory can be characterized as *segmental* theories of the prosodic tier: the number of prosodic elements in an utterance corresponds intuitively to the number of segments it contains.

Hyman (1984; 1985) and McCarthy and Prince (forthcoming) have suggested a more radical proposal. The prosodic tier they favor has just one kind of unit, as in X theory, but instead of representing a segment, this unit represents the traditional notion of *mora*. The mora has a dual role in this theory. First, it represents the well-known contrast between light and heavy syllables: a light syllable has one mora, a heavy syllable two. Second, the mora counts as a phonological position: just as in earlier theories, a long segment is normally represented as being doubly linked. In the version of moraic theory I adopt here, the schematic syllables under (1) would be represented as in (2), where μ = mora:

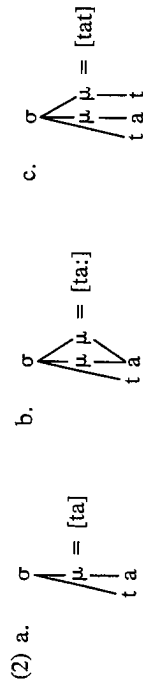

Moraic theory is not a segmental theory, as there is no level at which segment count is depicted. McCarthy and Prince take this as an advantage of the theory, in that there are no known phonological processes that count segments, although many processes count moras or syllables.

In this article I argue that the proposals of Hyman, McCarthy, and Prince for a moraic theory of segment structure are supported by typological observations about compensatory lengthening. I will make three basic points.

First, compensatory lengthening (hereafter CL) is subject to prosodic constraints: segments that undergo deletion yield CL only if they occupy particular positions within the syllable. Moreover, the choice of the nearby segment that lengthens to compensate for deletion is also limited. Such constraints show that CL is guided by a *prosodic frame* encompassing the relevant segments; the structure of the prosodic frame determines which segments may trigger CL when deleted, and which segments may lengthen compensatorily.

Second, moraic theory is well suited for the formal description of the prosodic frame, but segmental prosodic theories (X theory and CV theory) are not. In fact, when such theories are beefed up sufficiently to handle the full range of CL types, they reduce to something like the claim that any segment can lengthen to compensate for the loss of any other segment. This claim goes against a large body of evidence.

Third, as de Chene and Anderson (1979) originally suggested, the prosodic frame that governs CL is partly *language-specific*. In particular, only languages that have a syllable weight distinction allow CL. This fact also distinguishes the various theories: moraic theory posits partly language-specific prosodic structures, which vary according

to a language's criterion of syllable weight. In contrast, segmental prosodic theories assign the same structure to the same sequence (for the relevant purposes) in all languages. The moraic theory thus captures a cross-linguistic distinction missed by segmental prosodic theories.

This article is organized as follows. I first outline a specific version of moraic theory. Next, I show how simple cases of CL are accounted for by moraic and by segmental prosodic theories. I then discuss more unusual cases of CL and point out the expansions that they require in the power of segmental prosodic theories. This somewhat detailed section is crucial to the argument: the aspects of CL that I propose to explain through the notion of prosodic frame might also be explained by limiting the possible melody-to-skeleton associations permitted in segmental prosodic theories. What I will show is that no such limitations are tenable.

With this done, I give the central argument: the typology of CL demonstrates that it takes place within a prosodic frame of the kind provided in moraic theory, and the segmental prosodic theories are unable to account for the same facts. Further, I show that the segmental prosodic theories are unable to account for the correlation of CL with language-specific criteria of syllable weight.

In the remaining sections I discuss some additional issues in moraic theory, examine earlier work, and summarize the results.

For convenience, in what follows I will use X theory as the representative of all segmental prosodic theories. The arguments against X theory can be translated into arguments against CV theory without difficulty.

2. Moraic Phonology

An important aspect of both Hyman's (1985) and McCarthy and Prince's (forthcoming) work is the claim that the moraic structure of languages can vary. For instance, in some languages (such as Latin) CVV and CVC syllables count as heavy and CV as light; whereas in others (such as Lardil) only CVV is heavy and both CVC and CV are light. The claim of moraic theory is that these languages differ in their rules for assigning moraic structure; CVC is assigned two moras in Latin and one mora in Lardil.

Languages that exhibit a syllable weight distinction typically also have a vowel length distinction, and vice versa. This is to be expected in a moraic theory, since the same formal configuration, bimoraic syllables, is used to represent both. We would not expect the correlation to be absolute, however: a few languages allow heavy syllables but do not permit a vowel to occupy two moras (see below); and a language could in principle have long vowels but happen to lack phonological rules that diagnose a syllable weight distinction.

The existence of language-particular moraic structure is an important part of the theory: it predicts that in the absence of additional adjustment rules, the same criterion of syllable weight will be relevant throughout the phonology of a single language (Hyman (1985, 12)). Thus, in Latin (Allen (1973)) CVC counts as heavy for multiple rules and

constraints (for instance, stress, metrics, and Iambic Shortening). In contrast, in Lardil several rules (truncation, augmentation, reduplication) count CVC as light (Hale (1973), Wilkinson (1988)).

Although isolated problems exist, the idea of language-particular moraic structure seems well motivated. Contrary to the (implicit) prediction of *SPE* (Chomsky and Halle (1968)), a typical phonology is not a random collection of possible rules but an integrated system. By factoring out moraic structure as an overall property of a language's phonology, we come closer to a theory that describes phonological systems rather than just rule collections. As we will see, the matter of language-particular phonological structure becomes particularly clear in reference to CL.

2.1. *Underlying Forms and Rules*

An explicit moraic theory must characterize the ways in which individual languages assign moraic structure and where possible also develop principles that are invariant across languages.

Languages differ in the extent to which moraic structure is phonologically contrastive. Below I discuss the moraic structures that must occur in underlying forms for at least some languages, noting that in other languages the same structures may be derivable by rule. My account follows in certain respects the proposals of van der Hulst (1984, 68-73).

In languages with contrastive vowel length, long vowels have two moras, short vowels one. I assume that this is reflected directly in underlying forms:

$$(3) \text{ a. } \begin{array}{c} \mu \\ \mu \\ \vee \\ \cdot \text{ i} \end{array} = /i:/ \qquad \text{ b. } \begin{array}{c} \mu \\ \mu \\ | \\ \text{ i} \end{array} = /i/$$

It is often assumed that syllabicity is not represented on the segmental tier. If this is the case, we must face the fact that there are languages in which glides and short vowels contrast (see Guerssel (1986) for Berber, Harris (1987) for Spanish, and Hayes and Abad (forthcoming) for Ilokano). This contrast can be represented if we adapt an idea of Guerssel's and assign no mora at all to an underlying glide, as in (4):

$$(4) \begin{array}{c} \mu \\ \mu \\ | \\ \text{ i} \end{array} = /y/$$

The basic principle assumed is that segments receive the same number of moras underlyingly that, in the absence of additional rules, they will bear on the surface.

This principle can be extended to consonants. Ordinary short consonants are represented as underlyingly morainless, giving them the same underlying structure as glides:

$$(5) \begin{array}{c} \mu \\ \mu \\ | \\ \text{ n} \end{array} = /n/$$

The claim is that short consonants will not bear a mora unless assigned one by rule (see below).

Geminates almost always bear a mora; for example, a sequence like [anna] has three moras, versus two for [ana]. To distinguish geminates from single consonants, I assign them a single mora underlyingly:

$$(6) \begin{array}{c} \mu \\ \mu \\ | \\ \text{ n} \end{array} = /nn/$$

The surface double linking of a geminate is derived by the rules of syllabification outlined below and is not present in underlying forms, as in segmental prosodic theories.

The remaining case is a consonant linked underlyingly to two moras:

$$(7) \begin{array}{c} \mu \mu \\ \vee \\ \text{ n} \end{array}$$

This configuration is rare, but it does appear in Kimatuumbi (Odden (1981)), which permits long syllabic [mm,nn,pp], and in Gokana (Hyman (1985, 42)), which has [mm].

The structures outlined in (3)-(7) receive their explicit interpretation when they are grouped into syllables by a syllabification algorithm. Syllabification has attracted sophisticated theoretical attention (see, for example, Steriade (1982), Dell and Elmedlaoui (1985), and Itô (1986)), and the following is intended only as a cursory account. I suggest that syllabification consists of the following: (a) selection of certain sonorous moraic segments, on a language-specific basis, for domination by a syllable node; (b) adjunction of onset consonants to the syllable node, and of coda consonants to the preceding mora. Adjunction is subject to language-specific conditions on syllable well-formedness and the division of intervocalic clusters. The following schematic derivations illustrate the procedure:

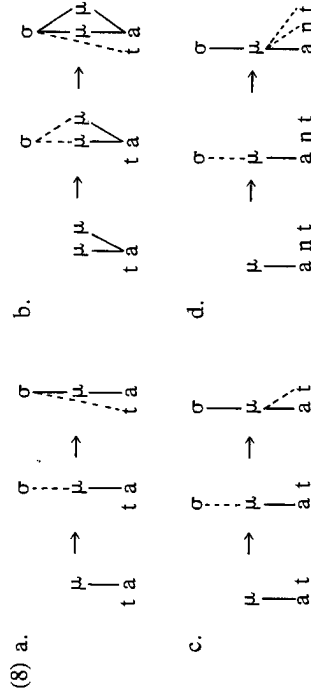

I assume that an underlying geminate (one mora) or long syllabic consonant (two moras)

has its consonant melody "flopped" onto a following vowel-initial syllable. This creates an onset (hence a preferred syllable structure) without disrupting moraic value:

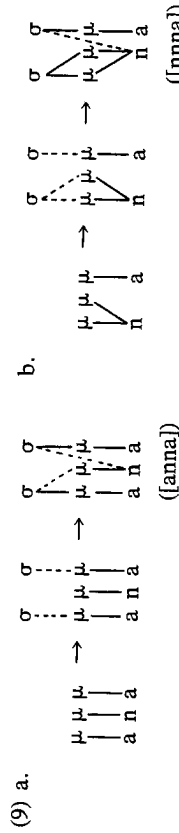

It can be seen that the proposed underlying form for a geminate is not so abstract as it might first seem, since the underlying form depicts the surface moraic value. The general principle is that contrastive mora count, not length per se, is represented underlyingly.

Moraic consonants sometimes occur without an adjacent vowel, as in the case of syllabic nasals (for instance, [nta]). Such moraic consonants can have the same underlying representation as geminates, the difference being that the flopping process of (9) is inapplicable, so that the consonant bears only one link on the surface and serves as the nucleus of a separate syllable. The existence of the flopping process described under (9) is supported by the patterning of syllabic nasals in Gokana (Hyman (1985, 41)), where it accounts for actual alternations such as [n̄] 'inside' ~ [n̄m̄] 'inside this', from /n̄-ɪ/.

The next ingredient of the analysis is the set of language-specific rules that supply "weight by position"—in other words, render closed syllables heavy in certain languages. The basic idea is that certain coda consonants are given a mora when they are adjoined to the syllable, by the following rule schema:

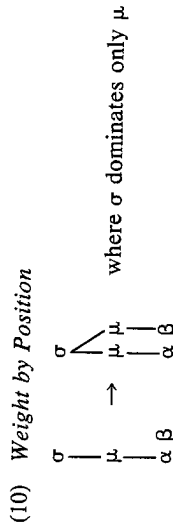

Following earlier work, I assume that prevocalic consonants must be parsed as non-moraic onset elements, and thus can never receive weight by position. The Weight by Position rule is illustrated in (11) with schematic forms for a language in which all closed syllables count as heavy.

The scheme just outlined is the most typical case for languages in which CVC counts as heavy. We must also account for languages like Lardil, where CVC is light. I assume that such languages have no Weight by Position rule, so that the final consonant is made a daughter of the final mora. Hyman (1985, 8) points out that in some languages only a subset of the consonants make their syllable heavy when they occur in coda position. This can be described by placing restrictions on β in the language-particular version of the Weight by Position rule.

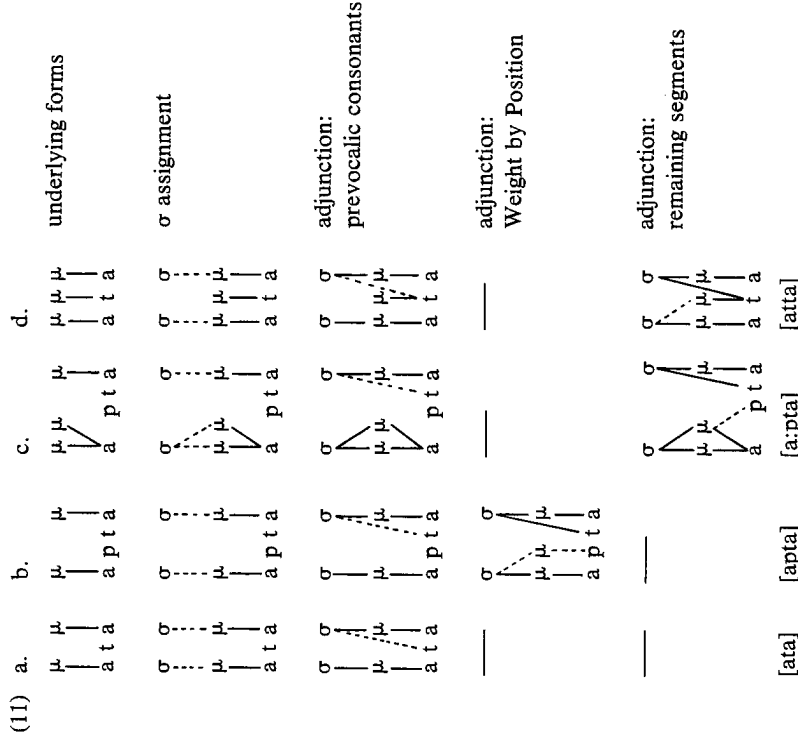

Weight by Position is formulated to produce syllables with a maximum of two moras. This is a strong claim; it says that distinctions of syllable weight are at most binary. The claim is probably too strong, and I will return to this issue later in the article.

This completes the set of rules for assigning moraic structure. Note that the full variety of underlying forms is relevant only for languages that employ moraic structure contrastively; in fact, many languages need not include moras in underlying forms at all. If (a) the distribution of high vowels and glides is predictable, (b) there is no vowel length contrast, and (c) there are no geminates, then underlying forms may consist simply of segmental strings, with all moras inserted by rule.

My proposal differs somewhat from those of Hyman and of McCarthy and Prince. The main argument for my analysis is that it provides the simplest description of possible contrasts in mora count. The three-way contrast in the vocoid series /y/ - /i/ - /i:/ is represented as the distinction between zero, one, and two moras, which is the same as the surface mora count of these segments. The three-way contrast among consonants

shown in (5)–(7) is also represented as a zero – one – two contrast in mora count, again reflecting surface form. By adopting these underlying forms, I believe that most of the criticisms of moraic phonology made by Odden (1986b) can be answered satisfactorily.

My proposal is also to be preferred, I believe, to accounts that place actual syllable structure (rather than just moraic structure) in underlying forms. The reason is that there are apparently no cases in which the division of consonants into syllables is underlyingly contrastive, as for example in /a.bia/ versus /ab.la/. A theory that includes full syllable structures in underlying forms predicts that these could exist. My claim is that there is no such thing as contrastive syllabification, only contrastive mora structure.

To summarize so far, I assume that moras appear in underlying representation, to represent length and syllabicity contrasts. Moras can also be created by language-specific versions of the Weight by Position rule. Other than that, nonmoraic segments are simply adjoined to the appropriate position: the mora for syllable-final consonants and the syllable for syllable-initial consonants. The representations that result appear to be adequate for the two tasks that moraic theory must carry out: representation of segment length and of syllable weight.¹

3. Compensatory Lengthening in X Theory and Moraic Theory

Compensatory lengthening can be defined as the lengthening of a segment triggered by the deletion or shortening of a nearby segment. Here is a simple example, taken from Ingria (1980). In Latin the segment /s/ was deleted before anterior sonorants (it apparently went through an intermediate stage of [z]; I ignore this and other complications). When the deleted /s/ followed a vowel, the vowel became long, as shown in (12):

- (12) a. $s \rightarrow \emptyset / \begin{bmatrix} + \text{son} \\ + \text{ant} \end{bmatrix}$
 b. *kasnus → ka.nus 'gray'
 *kosmis → ko.mis 'courtous'
 *fideslia → fide:lia 'pot'

A strictly linear theory of phonology, such as that proposed in *SPE*, has difficulties in describing this change. The /kasnus/ → [ka:nus] case can be described using transformational notation, as in (13):

- (13) a. $Vs \begin{bmatrix} + \text{son} \\ + \text{ant} \end{bmatrix}$
 1 2 3 → 1 1 3
 b. /kasnus/ → ka:nus = [ka:nus]

However, this rule turns out not to cover all the relevant cases, because *word-initial* /s/ also deleted before anterior sonorants:

¹ Discussion of further issues in moraic phonology not directly related to CL appears in the Appendix.

- (14) *smereo: → mereo: 'deserve-1 sg.-pres.'
 *snurus → nurus 'daughter-in-law'
 *slu:brikus → lu:brikus 'slippery'

Rule (13a) fails to predict this. The problem that a linear phonological theory faces is to formulate a rule that deletes /s/, compensatorily lengthens a preceding vowel, yet is also able to delete /s/ when no vowel precedes it. There is no clear solution to the problem in linear theory.²

Both X theory and moraic theory are able to overcome this difficulty.

3.1. X Theory

In X theory, the central insight is that the deletion of /s/ must take place on the segmental tier only. This leaves an empty X slot on the prosodic tier. If we then assume a rule that spreads a vowel melody onto a following tautosyllabic empty X position, we derive a long vowel. Note that in the derivation of (15c), I have suppressed the Rhyme node, a practice I will follow throughout to save space.

- (15) a. /s/ Deletion
 $s \rightarrow \emptyset / \begin{bmatrix} + \text{son} \\ + \text{ant} \end{bmatrix}$ (segmental tier only)
- b. *Compensatory Lengthening*
 $X X']_{\text{syl}}$ where X' is an unaffiliated prosodic position

c. Example: *kasnus → ka:nus

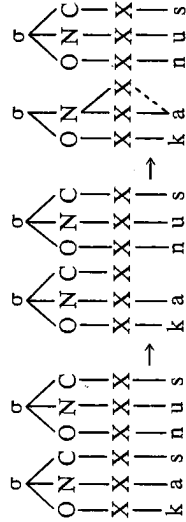

In (15c) the output form has undergone readjustment of its syllable structure, so that the newly created long vowel is syllabified as a long nucleus rather than as a nucleus

² A diachron linearist might write two rules: one lengthening vowels before /s/ + [+ant, +son] clusters and another deleting /s/ before [+ant, +son]. This is clearly undesirable, because (a) vowels typically do not lengthen before clusters, (b) the appearance of the same /s/ + [+ant, +son] cluster in both rules is highly suspicious, and (c) the lengthening is not depicted as compensatory (that is, the lengthened vowel does not take up the time vacated by the /s/). Those not convinced by these problems should consult Odden (1981), where it is shown that the same two-rule strategy applied to Kimatuumbi would fail on empirical grounds.

+ coda sequence. The assumption behind this, following McCarthy (1979) and others, is that syllabification applies throughout the derivation to adjust the ill-formed outputs of rules. This assumption will be important in what follows.

For the cases in Latin where /s/ deletes initially, I assume a convention that is widely supported in the literature: stray elements that are not filled by rule are deleted. This allows /s/ to disappear word-initially without a phonetic trace:

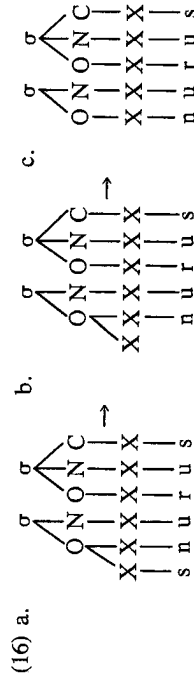

This argument for X theory is due to Ingria (1980). He expresses it in a different notation, which I have translated for consistency.

3.2. *Moraic Theory*

The moraic account of the Latin facts would be essentially the same as in X theory: the /s/ deletes only on the segmental tier, as in (17a). If a mora is stranded, it is filled by spreading from an immediately preceding vowel by the rule stated in (17b).

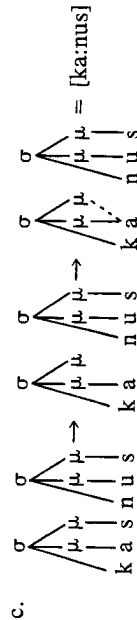
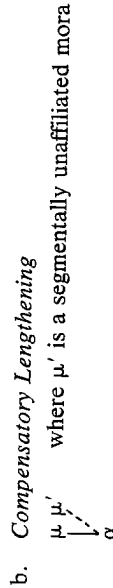
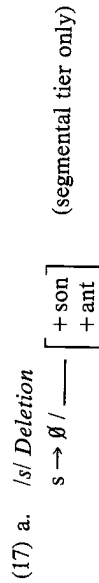

The assignment of a mora to the coda consonant /s/ is well motivated: CVC syllables in Latin behave as heavy for purposes of stress, metrics, and other phenomena.

If the /s/ is word-initial, it has no moraic value. Because of this, /s/ Deletion word-initially does not strand anything, and nothing further happens.

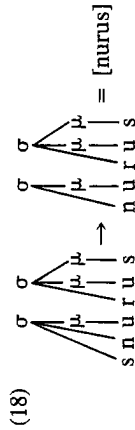

Note that moraic theory provides a somewhat neater account of the CL process. We need not stipulate that vowel melodies spread only onto syllable-final empty positions, because it is only in syllable-final position that an empty position is created—this is independently motivated by the fact that only syllable-final consonants make their syllable heavy. This point will be made in more forceful terms later on.

To summarize: both X theory and moraic theory can provide an adequate account of Latin CL, as well as a large number of parallel cases. Thus both are a clear improvement over a linear model of phonology. The crucial principle common to both theories, which will be important later, is the following: for CL to occur, deletion must create an empty prosodic position (X or μ).

3.3. *On the Status of Compensatory Lengthening Conventions*

In both (15b) and (17b) the CL process is stated as though it were a language-specific phonological rule. This is unsatisfactory, as one would like to make CL an automatic consequence of the deletion. For this reason, Ingria (1980), Steriade (1982), and others have suggested universal conventions that yield CL as an automatic result.

The difficulty with this is that some languages (for instance, Finnish) lack CL entirely, even though long vowels are possible and the relevant deletion processes exist. Further, certain other languages (for instance, Lesbian and Thessalian Greek; Steriade (1982), Wetzels (1986)) fill an empty syllable-final position not by lengthening the vowel but by spreading the following consonant leftward to create a geminate. In Tiberian Hebrew (Lowenstamm and Kaye (1986)) the situation is more complex: empty coda positions are filled by gemination in the normal case, but by vowel lengthening when the following consonant belongs to the class of gutturals, which do not permit gemination.

On the other hand, there are facts suggesting that it would be wrong to characterize CL as a language-particular phonological rule, ordered among the other rules. The reason is that in a number of languages (for instance, Ancient Greek (Steriade (1982), Wetzels (1986)), Turkish (Sezer (1986)), and Latin (Bichakjian (1986))) several distinct deletion rules lead to CL. If CL is a rule, and if we are to analyze the system without loss of generality, then CL must be ordered after all the deletion rules that trigger it. But this implies that empty elements persist through much of the derivation (from the first deletion rule up to the CL rule), a claim that is unsupported by the evidence and leads to considerable excess descriptive power (Dresher (1985)). The more reasonable assumption, then, is that CL occurs immediately following every deletion rule. This implies that CL cannot be an ordinary, linearly ordered phonological rule.

The correct view, I believe, is that CL rules such as (17b) form part of the *syllabification principles* of individual languages. That is, the way in which empty prosodic positions are provided with segmental content forms part of syllabification. The syllable-forming rules for an individual language may specify that empty prosodic positions are syllabified by spreading from the preceding vowel (as in Latin and most dialects of Ancient Greek); or from the following consonant (as in Lesbian and Thessalian Greek); or not at all (as in Finnish); or even variably, depending on whether the following consonant is allowed as a geminate, as in Tiberian Hebrew.

Attributing CL to syllabification provides a plausible account of two facts. First, as McCarthy (1979) has argued, syllabification rules apply whenever their structural description is met. Second, syllabification rules are language-specific, within certain universally determined limits. These two properties are what we want to attribute to CL: typically, it is pervasive within an individual language, but the mechanism that yields it is not universal.

It may be asked why a spreading operation should be included in the syllabification mechanisms. A plausible account of this is provided by Itó's (1986) notion of Prosodic Licensing: phonological material must be incorporated into the next higher level of prosodic structure; otherwise, it is deleted by Stray Erasure (Steriade (1982), Harris (1983)). A natural extension of this principle would state that higher-level phonological elements, such as moras, are also subject to Stray Erasure if they fail to dominate any lower-level element. The spreading operations embodied in language-specific CL conventions form part of the syllabification algorithm because they have the effect of licensing empty moras.

A final note: even in a language whose syllabification principles include a CL convention, CL is *not* the inevitable result of consonant loss in the environment of vowels, even in languages that have phonemic vowel length. For example, Sezer (1986) shows theory of CL must allow for the phenomenon, but not require it. This is in fact straightforward in multitiered theories, because rules of deletion can be stated in more than one way. If consonant loss is expressed as deletion of an entire segment complex, including the associated element on the prosodic tier (X or μ), then there will be no CL, because there will be no stranded element. In what follows I will focus on rules in which deletion takes place on the segmental tier only, so that CL is possible. However, it should be kept in mind that the occurrence of CL is not a necessary prediction of the theory.

4. Three Further Compensatory Lengthening Types

A valid theory of the prosodic tier should make correct typological predictions. In the area of CL, we want to specify what kinds of CL are characteristically found across languages, and which are unattested or rare. There are two approaches that we can take. One is to allow the representations to do the work: the possible relinkings and rearrangements of the segmental tier with respect to the prosodic tier are assumed to be

essentially free (subject to general principles such as the ban on crossed association lines), and the CL types predicted not to exist are the ones that the representations cannot generate. This is the approach I will take for moraic theory in what follows.

The other approach is to provide explicit constraints on what can link to what. For example, de Chene (1987), working in a CV framework, suggests that to the extent that a single segment can link to the sequence CV at all, the result is interpreted not as a long segment but as a sequence; for example, /i/ linked to CV depicts [yi], not [i:].

The goal of this section is to show that the latter approach faces severe empirical problems. There exist CL types that, although reasonably well attested cross-linguistically, require quite peculiar rearrangements of segmental association lines when treated in X theory or similar frameworks. The picture that emerges is that very little can be said about what can associate to what in a segmental prosodic theory. This result is a necessary preliminary to the section that follows, which presents the central typological arguments.

4.1. Double Flop

The mechanism of CL that I will call *double flop* was first employed for the description of Ancient Greek in independent work by Steriade (1982) and Wetzels (1986). Later, Hoek (1986) located cases of double flop in other languages. I will focus my summary on Steriade's and Wetzels's accounts of Greek.

Various consonant deletions in the dialects of Ancient Greek gave rise to CL. What is striking about some of these is that the vowel that lengthened was not adjacent to the consonant that deleted. For example, in East Ionic and other dialects deletion of /w/ lengthened the vowel that preceded the /w/ across an intervening consonant:

- (19) *woikos → oikos 'house'
 *newos → neos 'new'
 but *odwos → o:dos 'threshold'

To account for this aberrant case, it initially seems plausible to posit an intermediate stage in which the /w/ metathesized with the preceding consonant before deleting, as in *odwos* → *owdos* → *o:dos*. Both Steriade and Wetzels show that this is untenable: not only is the hypothetical intermediate stage unattested in the written record, but in addition /w/ that *originally* occupied syllable-final position did not delete: *awlaks* 'furrow'.

The solution that Steriade and Wetzels propose is statable only in a multitiered theory: when postconsonantal /w/ deletes, the preceding consonant shifts its association to fill the vacated X slot. This process creates a new empty position, which is filled by spreading of the preceding vowel segment, in a double flop maneuver (see (20)). Wetzels and Steriade note that the same basic pattern was found in other CL processes of Greek: deletion of /h/ and /y/ also lengthened preceding nonadjacent vowels and can be accounted for only by the mechanism of double flop.

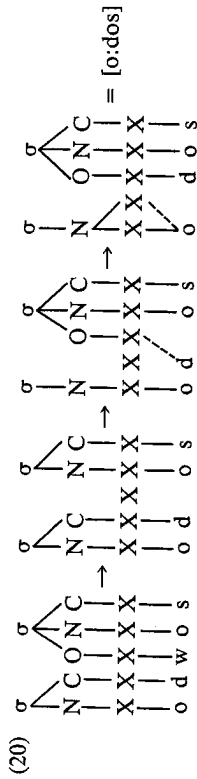

Moraic theory also countenances double flops. In the example in (20) the /d/ would first receive weight by position, since CVC is a heavy syllable in Greek. When the /w/ deletes, the /d/ resyllabifies, eliminating the highly marked syllable juncture *od.os*. The resyllabification empties a mora and allows the preceding vowel to lengthen:

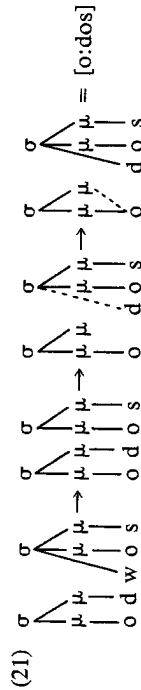

Under both theories, the mechanism of double flop allows for nonlocal CL, in which the deleting and compensating segments are nonadjacent. The possibility of double flop substantially increases the power of prosodic theories, in a way that will be crucial to the argument below.

4.2. CL by Vowel Loss

The pattern here is VCV → V:Cf; that is, a vowel is dropped with CL of the vowel of the preceding syllable. As Hock (1986) shows, this phenomenon is attested in many languages. To illustrate it, I will discuss an example from Middle English.

A well-known Middle English sound change, the subject of a large body of scholarly work, is said to have taken the form "Lengthen stressed vowels in open syllables." Interestingly, this turns out not to be the proper characterization of the rule. Minkova (1982) took the trouble to collect all the forms of early Middle English that could have undergone the rule, and found that lengthening of stressed vowels in open syllables is actually only a sporadic phenomenon. The real generalization, which holds true for 97% of the relevant cases, is that a stressed penult in an open syllable lengthened just in case a word-final schwa was dropped, as in [talə] → [ta:i]. Modern English *tale*. Minkova's discovery demands a rethinking of formal accounts of the process.

Two facts are relevant. First, an account positing the sequence of changes [talə] → [tal] → [ta:i] is untenable, because words that originally had the syllable structure of [tal] did not lengthen. In other words, lengthening was genuinely compensatory. Second, Middle English resembles Ancient Greek in that CL is caused by the deletion of a segment that is not adjacent to the vowel that lengthens. An intermediate metathesis stage is unlikely, being unattested in the record both for Middle English and for all known parallel

examples. Thus the mechanism needed is some kind of double flop: only this will create an empty position for the stressed vowel to spread onto.

But when we implement this suggestion in X theory, we get an odd result: the consonant rendered word-final by Schwa Drop must flop onto an X position previously syllabified as a nucleus. The stressed vowel segment must then spread onto an X slot previously syllabified as an onset:

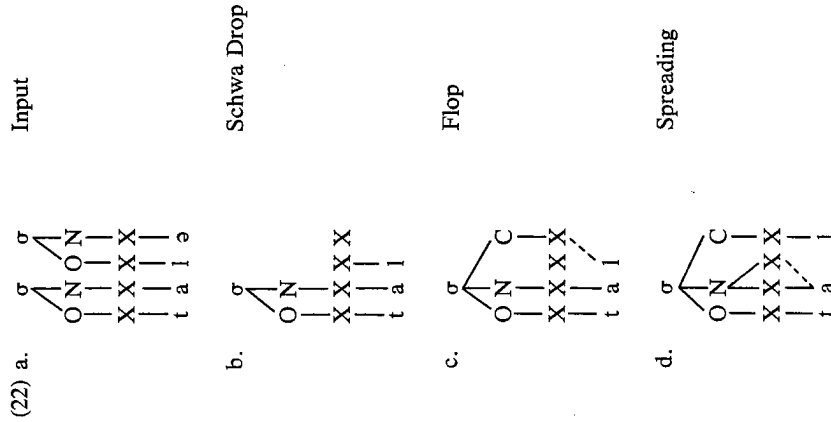

The adjustments of syllable structure shown in (22) require comment. I will assume that the loss of the vowel segment caused by Schwa Drop renders the entire second syllable ill-formed, so that the entire syllable structure is eliminated. An explicit convention to accomplish this is proposed below. The remaining adjustments of syllable structure follow from the assumption made above that syllabification is an everywhere process.

rising sonority, with triple clusters occurring almost exclusively in borrowed words. Sequences of the form VCCV are normally divided into syllables as VC.CV, even for clusters such as /b/ that familiar European languages divide as V.CCV. CVC syllables count as heavy in the Ilokano stress pattern.

Other than pronominal enclitics, Ilokano has only two suffixes, *-an* and *-en*. These have multiple uses, often forming circumfixes in combination with prefixes. Most Ilokano stems have at least one *-an* or *-en* form.

The vowels of this dialect are /i/, /e/, /a/, /o/, and /u/; the contrast between the last two is marginal. Stems may end with a consonant or with one of the vowels /i, e, a, o/. Vowel sequences created by the suffixation of *-an* or *-en* to /a/-final stems are split up by an epenthetic [ʔ]. When a stem ends in /i/, /e/, or /o/, a vowel sequence created by suffixation is usually resolved by converting the stem-final vowel to a glide: /i/ and /e/ become /y/, and /o/ becomes /w/.

The interest of the glide formation rule is that it often triggers CL (that is, gemination) of the preceding consonant. This CL is subject to a gradient requirement that the consonant undergoing it should be of low sonority. The following chart summarizes the data:

- (27) a. *Single Obstruents: Usually Geminate*
- | | | | |
|--------|---------------|----------------|---------------------|
| lúto | 'to cook' | luttw-én | 'cook-goal focus' |
| ʔáso | 'dog' | pag-ʔassw-án, | 'place where dogs |
| ʔapó | 'grandfather, | pag-ʔasw-án | are raised' |
| | leader' | kina-ʔappw-án, | 'leadership |
| bági | 'body, self' | kina-ʔapw-án | qualities' |
| ʔatáke | 'to attack' | bagy-én, | 'to have as one's |
| | | pag-ʔataky-án, | own' |
| | | pag-ʔataky-án | 'place where an |
| | | | attack takes place' |
- b. *Single Nasals and /l/: Sporadically Geminate*
(optionality, possibly lexical variation)
- | | | | |
|--------|--------------------|-----------------|--------------------|
| dámo | 'the first time' | dammw-én, | 'to be new to |
| | | ʔdammw-én | something' |
| ʔalíno | 'to have sensitive | na-ʔalínw-án, | 'to become |
| | teeth' | ʔna-ʔalimnw-án | sensitive' |
| ʔaliṅó | 'wild boar' | pag-ʔaliṅw-án, | 'place where boars |
| | | ʔpag-ʔaliṅpw-án | are found' |
| bále | 'value' | balyán, | 'to change' |
| | | ʔbally-án | |
- c. *[r, ʔ, w, y]: Never Geminate*
- | | | | |
|------|-----------|-------------|----------------|
| ʔári | 'leader' | pag-ʔary-án | 'place of |
| káro | 'intense' | karw-án | leadership' |
| | | | 'to intensify' |

- | | | | |
|--------|---------------|-----------|---------------------|
| ʔáyo | 'to cheer up' | ʔayw-én | 'cheer up-goal |
| | | | focus' |
| babáwi | 'regret' | babawy-én | 'regret-goal focus' |
- d. *Consonant Clusters: Neither Member Geminates*
- | | | | |
|-------|----------------------|--------------|--------------------|
| sakdó | 'to fetch water' | pag-sakdw-án | 'place where water |
| | | | is fetched' |
| ʔárko | 'arch' | ʔarkw-án | 'to arch' |
| sublí | 'to return' | pag-subly-án | 'place that one |
| | | | returns to' |
| ʔakló | 'ladle' | ʔaklw-án | 'to ladle out-goal |
| | | | focus' |
| ʔapri | 'smelling like fish' | na-ʔapryán | 'to be made to |
| | | | smell like fish' |

It is crucial to my argument that consonants do not generally become geminates before glides; that is, the lengthening is genuinely compensatory. This point is made by the following examples, which are never heard with gemination:

- (28) botélya 'bottle' wetwét 'tight as a door'
- yagyág 'to harangue' ʔag-wad-wádag 'is flinging aside'
- yekyék 'coughing sound' ʔag-wak-wákas 'is getting rid of'
- radwár 'to graduate' wagwág 'to shake (tr.)'

As before, let us consider what needs to be done with X theory and moraic theory to handle the data. In X theory, glide formation rules are most straightforwardly stated as changes in syllable structure. Here, a nuclear X in prenuclear position would be resyllabified as an onset:

- (29) N O
 | |
 X → X / — N
 [-cons] [-cons]
 [-low] [-low]

However, such an account would be inadequate for Ilokano, because it removes the possibility of CL. That is, once an input form like (30a) is converted to (30b), the glide derived from a vowel becomes indistinguishable from an underlying glide, as in (30c):

- (30) a. $\begin{array}{c} \sigma \\ \diagup \quad \diagdown \\ \text{O} \quad \text{N} \quad \text{O} \\ | \quad | \quad | \\ \text{O} \quad \text{N} \quad \text{O} \\ | \quad | \quad | \\ \text{X} \quad \text{X} \quad \text{X} \\ | \quad | \quad | \\ \text{b} \quad \text{a} \quad \text{g} \quad \text{i} \quad \text{e} \quad \text{n} \end{array}$
- b. $\begin{array}{c} \sigma \\ \diagup \quad \diagdown \\ \text{O} \quad \text{N} \quad \text{C} \\ | \quad | \quad | \\ \text{O} \quad \text{N} \quad \text{C} \\ | \quad | \quad | \\ \text{X} \quad \text{X} \quad \text{X} \\ | \quad | \quad | \\ \text{b} \quad \text{a} \quad \text{g} \quad \text{i} \quad \text{e} \quad \text{n} \end{array}$
- c. $\begin{array}{c} \sigma \\ \diagup \quad \diagdown \\ \text{O} \quad \text{N} \quad \text{C} \\ | \quad | \quad | \\ \text{O} \quad \text{N} \quad \text{C} \\ | \quad | \quad | \\ \text{X} \quad \text{X} \quad \text{X} \\ | \quad | \quad | \\ \text{i} \quad \text{a} \quad \text{g} \quad \text{i} \quad \text{a} \quad \text{g} \end{array}$

Since /bagi + en/ surfaces as [baggjen] 'to have as one's own' and /yagyag/ as [yagyag] 'to harangue', rule (29) is inadequate.

Another possibility is to flop the consonant segment onto the following X slot, reinterpreting the partially dislodged vowel segment as a glide:

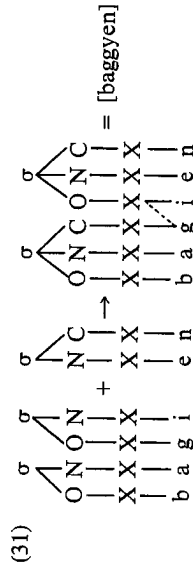

Although this derives the correct result in this particular form, it is untenable in light of other facts about Ilokano phonology. In particular, the distribution of nonlow vowels is such that one must allow Glide Formation to apply to a vowel even when no consonant precedes it (Hayes and Abad (forthcoming)). The situation is thus parallel to what Ingria (1980) describes for Latin (section 3.1), and the argument is the same: to avoid stating Glide Formation twice in the grammar, we must express CL as the filling of a slot vacated by Glide Formation.

In X theory, this can be done by invoking a double flop. Suppose that Glide Formation consists of flopping the melody of a nonlow vowel onto the X slot of a vowel on its right, by the following rule:

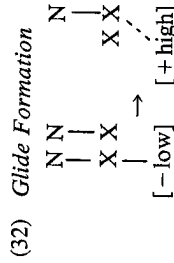

For glides not preceded by consonants, the stranded X slot will delete without further effect. In the central cases like /bagi + en/ the rule will apply as follows:

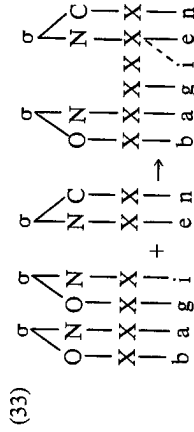

This first flop creates an empty X slot, and the syllable structure dominating /gi/ disappears by Parasitic Delinking (23). We can then derive CL by spreading the immediately preceding consonant onto the empty X, as follows:

(34) a. *Compensatory Lengthening (X Theory)*

X X' $\alpha = [-\text{son}]$: usually applies
 $\alpha = [+\text{nas}]$: sporadically applies
 $\alpha = r, y, w, ?$: inapplicable

b. *Application of CL* c. *Syllabification*

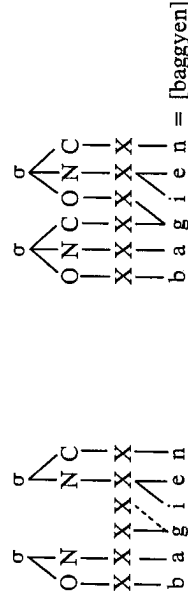

This grinds out the facts, but at a cost: the long segment /gg/ occupies X slots that in the original form were syllabified as onset + nucleus. The significance of this expansion in the inventory of reassociations allowed under X theory will become clear below.

To complete the X theory analysis, we must account for the cases of (27d), in which the vowel undergoing Glide Formation is preceded by a consonant cluster, and no CL occurs. This follows from fairly standard assumptions. For example, if we take the stem *báŋko* 'bench', add the suffix *-an*, and apply the rules stated above, we arrive at the configuration of (35b):

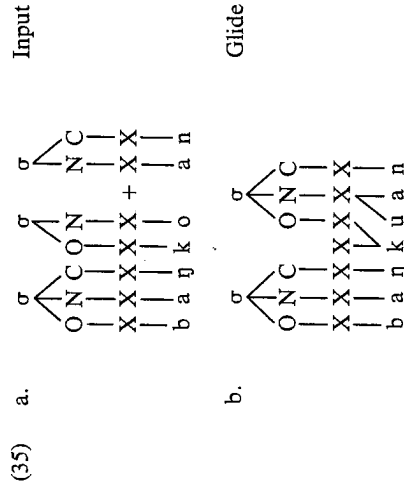

Here the consonant /k/ has undergone CL, just like the /g/ of /bagi/ in (34b). But the first X slot linked to /k/ cannot be syllabified, because Ilokano tolerates neither *[baŋk] nor *[kkwan] as possible syllables. Thus the convention of Stray Erasure (Steriade (1982), Harris (1983)) will apply to (35b), yielding the correct result, [bankwan]:

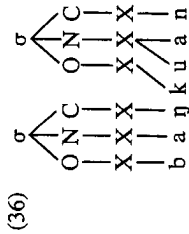

Consider now a moraic account of Ilokano CL. Here again, the crucial element is Parasitic Delinking, triggered by Glide Formation. I interpret the latter rule as a delinking operation: the stem-final vowel is disassociated from its mora, and by later processes is shifted over one slot to become a glide onset of the following syllable.

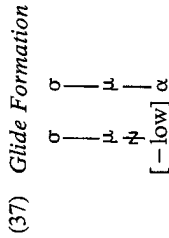

An application of the rule to our earlier case, /bagi + en/, is shown in (38). The output of the rule is immediately submitted to Parasitic Delinking.

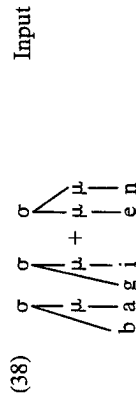

Recall further the assumption that syllabification of stray elements takes place throughout the phonological derivation. Since [ɣen] is a well-formed syllable in Ilokano, the syllabification principles will adjoin the stranded /gi/ sequence to the following syllable to yield (39):

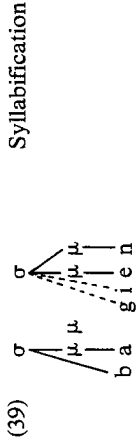

We are now in a position to describe the CL, because we have a stranded mora that is accessible to the /g/. The CL process can be written as in (40a); it applies to /bagi + en/ as in (40b):

(40) a. *Compensatory Lengthening (Moraic Version)*
Fill empty moras by spreading from the right.

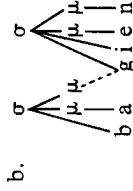

The mora filled by spreading is syllabified with the preceding vowel; note that [bag] is a well-formed syllable in Ilokano. The output obeys the general principle proposed by Itô (1986) that syllable structure is created maximally.

It remains to handle the various additional complications in the rule. The absence of CL in the cases like /baŋko + an/ → [baŋkwan] follows from the same account given for X theory: the first half of the geminate [kk] cannot be syllabified and is deleted by Stray Erasure. The other fact to be addressed is the variability of CL, based on the sonority of the consonant to be geminated: highly sonorous consonants ([r, ? w, y]) never lengthen; [l] and nasals sometimes lengthen; and obstruents usually lengthen. My strategy here is to allow the rule to apply blindly to all consonants, then trim back the excess with the following rule:

(41) *Degemination*

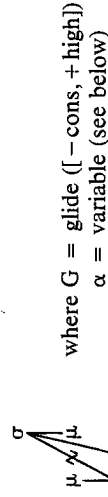

Obligatory: where α has the sonority of /r/ or greater
Usually applies: where α has the sonority of /l/ or a nasal
Sporadically applies: where α has the sonority of /s/ or less

A schematic derivation would be: *karo-an* becomes *karrwan* by CL, then *karwan* by Degemination. The crucial point is that Degemination is needed in the phonology of

Ilokano anyway, in order to remove *underlying* geminates that come to stand before a glide. An example here would be (42):

- (42) punnó punwán, punwán 'to fill'

The Degemination rule looks complex, but it makes sense in light of a finding of Murray and Vennemann (1983). Based on data from Germanic and other languages, Murray and Vennemann propose the following general law of preferred syllable structure:

- (43) *Syllable Contact Law* (Murray and Vennemann (1983))

A syllable contact of the form $C_1]_{\sigma}C_2$ is favored to the extent that the sonority of C_1 exceeds that of C_2 .

The Degemination rule of Ilokano is a clear instance of the law: it resolves complex consonant clusters (for instance, [rrw]), with the proviso that bad syllable contacts, such as $p]_{\sigma}Lw$, not be created.

4.3.2. *Managerial Lengthening in English*. The moraic analysis of Ilokano predicts the existence of another kind of CL. Consider the following intermediate representation, from (39):

- (44)
$$\begin{array}{c} \sigma \\ \swarrow \quad \searrow \\ \mu \quad \mu \\ \swarrow \quad \searrow \\ b \quad a \quad g \quad i \quad \dot{e} \quad n \end{array}$$
 /bagi + en/ \rightarrow

In Ilokano the stray mora that was created by Glide Formation is filled by spreading from the following consonant. But there is no reason why spreading could not take place from the preceding vowel, producing [ba:gyen]. According to the theory, it is an idiosyncrasy of Ilokano that spreading takes place from the consonant.

A case can be made that the other possibility, spreading from the vowel, arose in another language, namely Middle English. The relevant rule is the one whose modern descendent applies in words like *managerial*, *Newtonian*, and *Canādian*:

- (45) *Managerial Lengthening* (adapted from SPE, 181)

$$\left[\begin{array}{c} V \\ \text{---high} \end{array} \right] \rightarrow V: / \text{---}]_{\text{syll}} C_0 \left[\begin{array}{c} i \\ \text{---stress} \end{array} \right] V$$

That is, a nonhigh vowel in an open syllable lengthens before prevocalic stressless /i/. This statement of the modern rule, though accurate, provides no account of just why vowels should lengthen in this environment. In fact, for reasons to be made clear, I believe that the present rule is synchronically arbitrary. But the historical precursor of (45) can be described as an instance of CL.

Jespersen's (1909, 140–141) description of the historical facts is revealing: "When

a consonant is followed by two [adjacent] weak vowels in originally separate syllables, the preceding stressed vowel is long." The word "originally" is important here, because as Jespersen also points out (pp. 277–278), the earlier [iV] sequences had usually become [yV] by the early Modern English period. Current pronunciations with [iV] reflect a later reversion to the original vocalic forms, as is argued on synchronic grounds in Hayes (1982, 267–268). Luick (1907) presents evidence that the shift of [iV] to [yV] was roughly simultaneous with the first appearance of *Managerial Lengthening* in the grammar.

My suggestion is that the shift from [iV] to [yV] was not just simultaneous with the original version of *Managerial Lengthening* but in fact caused it, via a form of CL much like that of Ilokano. The mechanism is outlined as follows, with a derivation for the historical precursor of *patience*:

- (46) *patience* (original form)

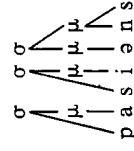

Glide Formation, Parasitic Delinking

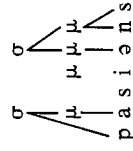

Syllabification

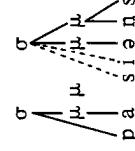

Compensatory Lengthening

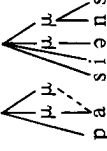

(= [pa:syəns], Modern English [peɪʃəns])

Evidence to support this account is provided by Jespersen, who notes the following (p. 141): "Words like *companion* with short /a/ are no exceptions to [the] rule . . . as this /i/ was not a separate syllable in Old F[rrench]: [mi/, /mj/ represents OF palatal *n* Thus also in *onion* [ɔniən] . *poniard* [pɔniəd] . *Spaniard* . *spaniel* and with OF palatal *l* . . . *battalion* [bətɛljən] . *valiant* [væljənt]." Jespersen's observation fits perfectly with the above account: if these words always had glides, they could not undergo Glide Formation; thus, no mora was made available to the preceding syllable.

The X theory account of the same facts would parallel the X theory account of Ilokano:

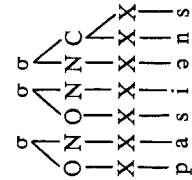
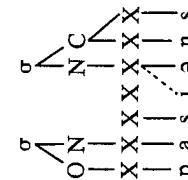
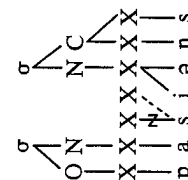
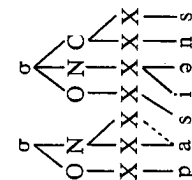
- (47) a.  Input
 b.  Glide Formation
 c.  Flop of /s/
 d.  Spread of /a/

Here again a consonant flops from onset to nucleus position and a vowel spreads onto the former onset X.

4.4. Summary So Far

The purpose of this section has been to show that the set of possible relinkings that X theory must allow to describe the instances of CL in the world's languages is considerably less constrained than has previously been supposed. In particular, to handle the case of Ilokano, X theory must allow long segments to be linked to X slots that originally were syllabified as onset + nucleus, as in (34b). Further, it must allow onset consonants to

flop onto X positions originally syllabified as nuclei, as in vowel loss cases (22c) and Middle English Glide Formation (47c). Finally, the latter two types show that X theory must allow vowels to lengthen by spreading onto former onset positions (22d), (47d)).

Such extensions have serious consequences, in that they subvert the main principles that have previously constrained the power of X theory: (a) double linkings to onset + nucleus, if they exist, do not represent length; (b) length-creating operations involve only spreading onto rhyme positions. With these gone, the theory comes close to maintaining that any segment can lengthen to compensate for the deletion of any other.

In contrast, moraic theory can treat the phenomena presented in this section without substantial expansions in its descriptive power: the essential mechanism is Parasitic Delinking, which appears to be needed in any event by X theory as well (see (22)).

5. The Argument from Typology

In this section I present the central argument: I describe two substantial asymmetries in the cross-linguistic behavior of CL and argue that these asymmetries support the claim that CL is governed by a "prosodic frame" of the type posited in moraic theory. X theory, weakened in its explanatory power by the results of the preceding section, is unable to explain the same facts.

5.1. A Typology of CL

In the following paragraphs I list an inventory of CL rule types I have culled from the literature. The typology bears a large debt to Hock's (1986) wide-ranging survey, as well as to de Chene and Anderson (1979). For the rarer types, I list a number of instances with citations.

5.1.1. "Classical." Classical CL is the lengthening of a vowel triggered by the dropping of a following coda consonant. Schematically, it looks like this:

- (48) a. a s t a b. a s t # c. a s # (input)
 a: Ø t a a: Ø t # a: Ø # (output)

From Hock (1986), de Chene and Anderson (1979), and my own search I have located 38 rules of this type from 26 languages; I assume from this that the phenomenon is not at all rare.

5.1.2. *Progressive and Regressive Total Assimilation of Consonants.* Total assimilation of consonants is not always viewed as CL, though in a prosodic theory it is formally equivalent to it. Here are schematic examples:

- (49) a. a s t a b. a s t a
 a s: Ø a a Ø t: a

I have not bothered to collect cases of this sort, since the phenomenon is so well attested.

5.1.3. *Glide Formation*. In cases of CL triggered by Glide Formation the empty phonological position is created by shortening rather than deletion. The best-known pattern, which is widespread among Bantu languages (see, for example, Odden (1981), Clements (1986)), works as follows:

- (50) t i a
t y a:

Other instances of this sort are found in Japanese (Poser (1986)), Old Icelandic (Hock (1986)), and Old English (Wright and Wright (1925)). Glide Formation can also lengthen the preceding consonant, as in Ilokano (51a), or the vowel of the preceding syllable, as in English *Managerial* Lengthening (51b):

- (51) a. a k i a b. e r i a
a k : y a e : r y a

5.1.4. *Prenasalization*. CL triggered by prenasalization is also widespread in Bantu languages (Odden (1981), Clements (1986)). In (52) [mb] represents a prenasalized stop:

- (52) a m b a
a : ∅ m̃ b a

5.1.5. *Double Flop*. CL through double flop is illustrated in (53):

- (53) o d w o
o : d ∅ o

The various dialects of Ancient Greek provide four instances of this sort (see section 4.1; also Steriade (1982), Wetzels (1986), and Hock (1986)). Hock (1986) notes the existence of this phenomenon in Akkadian and in Persian. The change in Old English found in forms like *holthes* > *hole-les* 'hole-gen.' (Campbell (1959, 104–105)) may also fall under this heading.

5.1.6. *Vowel Loss*. CL through vowel loss is illustrated in (54):

- (54) a l ə #
a : l ∅ #

This case is described under section 4.2 for Middle English. CL through vowel loss is surprisingly common. Hock (1986) points out examples in Balto-Slavic, Hungarian, Jutland Danish, Korean, various dialects of German, and the Slavic languages (for the latter see also Timberlake (1983a,b)). The same process occurs in Friulian, analyzed in Repetti (1987). CL of this type is clearly a synchronic rule of Yapese (Jensen (1977)); and Estonian (discussed below) also falls in this category.

5.1.7. *Inverse CL*. In cases of inverse CL a vowel deletes or shortens, with concomitant lengthening of the following consonant. This occurred in the history of Luganda ((55a), Clements (1986)) and as a sporadic phenomenon in Pali ((55b), Hock (1986, 441)).

- (55) a. a i k a b. a : k a
a k k a a k k a

A similar process occurs when the vowel that deletes is the only vowel of its syllable:

- (56) a. i l a b. p i l a
l l a p l l a

This occurred in Luganda (Clements (1986)), in Idoma (Abraham (1951), Hyman (1985)), and in Gã (Trutenau (1972)) and is found as a fast speech rule in French (Rialland (1986)).

5.1.8. *Summary*. The result of this survey is that CL constitutes a formally diverse set of phenomena. However, both X theory and moraic theory are sufficiently powerful to derive all the cases noted above. For the nonobvious cases, I have given derivations in section 4, and the remaining cases are straightforward. The greatest interest in the typology of CL lies in what appears not to exist.

5.2. *Two Asymmetries*

This section presents two asymmetries in the typology of CL, where CL in one configuration occurs, but its mirror-image counterpart does not.

5.2.1. *Onset Deletion*. Although CL from loss of coda consonants is very common, its opposite, CL from loss of onset consonants, appears not to occur. This has been pointed out by Donegan and Stampe (1982), by Hyman (1984), and by McCarthy and Prince (forthcoming). Possible cases of this sort include the following:

- (57) a. # s a b. o s a c. o s a
∅ a : o ∅ a : o : ∅ a
d. # s l a e. # s t a
s ∅ a : # ∅ t a :

The existence of an asymmetry is strongly supported by cases in which a consonant can delete from either onset or coda position, but triggers CL only when deleted from the coda. Sezer (1986, 231–232) presents an example from Turkish: an optional rule deleting /v/ before labial segments induces CL with coda /v/ but not with onset /v/. Thus *savmak* 'to get rid of' may be realized as [sa:mak], but *davul* 'drum' yields [dau], not *[da:ul]. Similar examples may be found for deletion of several other segments in Turkish (Sezer (1986, 229–230, 231, 248)); for deletion of /ʔ/ in Persian; for the loss of laryngeals in Indo-European (Hock (1986)); and for /r/-loss in Onondaga (Woodbury (1981)). Ancient Greek /w/ Deletion (Steriade (1982), Wetzels (1986)) forms a slightly different case: this rule triggered CL only when a preceding coda consonant was available for double flop; otherwise, /w/ was lost from onset position without CL.

There is an interesting case presented in the literature that claims CL for a case of onset deletion: Michelson's (1986) account of CL in Onondaga, an Iroquoian language. The facts here are worth reviewing.

According to Woodbury (1981), who reviewed the historical documents, before about 1750 Onondaga had an /r/ segment in its phonemic inventory. This segment deleted in all positions prior to 1852. Intervocally, the /r/ deleted without CL, as one would expect. /r/ before a consonant deleted with CL of the preceding vowel. When /r/ followed a consonant, the modern language shows [CV:] where earlier stages had [CrV].⁴ However, as the written record shows, there was no direct transition between the two stages. Rather, an intervening sound change broke up obstruent-/r/ clusters with an epenthetic [e]: [CrV] → [Ce:rV]. Later the [r] was dropped. The sequence [e + V] that resulted from [Ce:rV] coalesced to [V:], giving the present form of the language.

In her synchronic account of the alternations resulting from these developments, Michelson collapses the two stages of epenthesis and coalescence, expressing the lengthening of the vowel as direct compensation for the loss of the /r/. More precisely, she represents /r/ synchronically as an empty C position (Clements and Keyser (1983)), since all evidence for its earlier phonetic quality has disappeared. The basic mechanism looks like this:

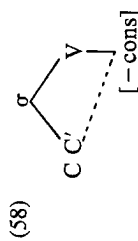

Though I cannot rule this out as a possible synchronic analysis, a clear alternative is available, that of formulating the synchronic account to recapitulate history. That is, we could insert an epenthetic vowel between consonants and empty C positions, then assimilate this vowel to the vowel that follows across the empty C:

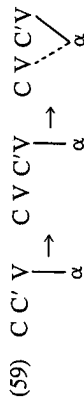

The empty C would delete by the general principle applying to unaffiliated elements, as in other analyses involving empty consonants.

The same process can be expressed moraically, provided we assume, following Hyman (1985, 58), that empty consonants are underspecified segmental matrices rather than prosodic positions. For example, in the theory of Clements (1985), we would posit that empty consonants are bare Root nodes.⁵ The process works as in (60), where β , α ,

⁴ The exact environment for lengthening here is apparently after a nonlaryngeal consonant, with sporadic lengthening after /h/. Thanks to K. Michelson for clarifying this and other aspects of Onondaga to me.
⁵ Space does not permit arguing the point in detail, but I would claim that the extensive literature on empty consonants has not shown that empty consonants are necessarily empty prosodic positions; rather, the arguments support the more general notion of a fully underspecified segment, which could just as well occupy the segmental rather than the prosodic tier.

and [] are the segmental tier representations for a consonant, a vowel, and a fully underspecified segment, respectively:

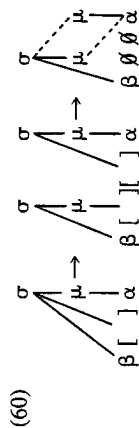

No matter how it is expressed, an analysis that recapitulates the historical developments does not seem appreciably more complex than Michelson's. Crucially, it does not involve CL triggered by onset deletion. I conclude that although Michelson's account is intriguing, it does not force us to abandon an otherwise valid cross-linguistic generalization.

A more difficult case is that of the Samothraki dialect of Modern Greek, as analyzed by Newton (1972, 76–81). Like Onondaga, Samothraki exhibits loss of onset /r/, with apparent CL of the following vowel. This may simply be a counterexample to the claimed generalization. However, there is an alternative possibility—namely, that the apparent CL was as in Onondaga the result of epenthesis, intervocalic /r/ loss, then merger of [VV] to [V:]. If the epenthesis took the form of vowel copying, the route taken would be [CrV] → [CV:rV] → [CV:].

The facts supporting this conjecture are as follows. (a) /r/ was in fact lost intervocally in Samothraki, without vowel lengthening. Since there would be no motivation for epenthesis in a VCV sequence, this is what we would expect. (b) Original VrC sequences show up as ViC. Newton suggests that the /i/ is an originally epenthetic vowel, with the development [VrC] → [VriC] → [ViC]. This supports the idea that prior to deleting, /r/ in Samothraki triggered epenthesis processes. (c) Most Modern Greek dialects have no vowel length distinction. Samothraki appears to have acquired phonemic vowel length from the developments involving /r/. De Chene (1979) presents substantial typological evidence that vowel length distinctions hardly ever arise from CL; by far the most common source for new phonemic long vowels is intervocalic consonant loss, with subsequent merger of /VV/ to /V:/. If we assume the epenthesis account, the Samothraki facts appear considerably more natural from a typological viewpoint.

I conclude from this that although further data are needed, the Samothraki facts are not necessarily an insuperable problem for the argument to be made here.⁶

5.2.2. *Mirror-Image Vowel Loss*. The other asymmetry that can be observed in the typology of CL concerns CL through vowel loss: in all known cases the vowel that

⁶ Davis (1985) points out a possible case of CL from onset loss in Maasai. However, as B. Levergood has pointed out (personal communication), the relevant examples also involve the conversion of a preceding vowel to a glide. An adequate analysis is possible in which CL is the result of Glide Formation, not onset loss.

lengthens in the syllable to the left of the vowel that deletes. Left-to-right CL, which would appear as in (61), appears not to exist:

- (61) # ə l a
- # ø l a:

I know of no candidate counterexamples.

5.3. *Assessing the Two Theories against the Typology*

Assuming these asymmetries are valid, we can address their implications for X theory and moraic theory.

5.3.1. *The Onset Deletion Asymmetry.* CL through onset deletion can be derived in X theory, as the following sample derivation shows:

- (62) a.  Input forms: /sa, /osa, /osa/

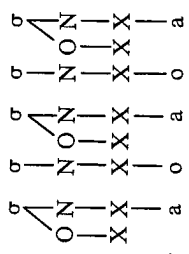
- b.  [s] -> ø

- c.  Compensatory Lengthening = [a:], [oa:], [o:a]

The crucial part of the derivation is (62c), where spreading onto a former onset position creates length. The only mechanism in X theory to exclude this possibility is to add constraints concerning what linkages are possible, and which ones count as length-creating. In section 4, however, I argued that such constraints are untenable: in particular, sequences formerly syllabified as onset + nucleus may appear as surface long segments, and vowels may spread onto former onset segments to create length.

In contrast, moraic theory correctly excludes CL from onset deletion, as both Hyman (1984) and McCarthy and Prince (forthcoming) point out. This follows from two basic principles: (a) in any prosodic theory, CL occurs only if deletion creates an empty prosodic position; (b) moraic theory does not assign prosodic positions to onset consonants. This is illustrated in (63):

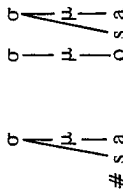
- (63) a.  Input forms: /sa, /osa, /osa/

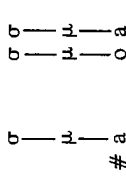
- b.  s -> ø

No element is stranded in these derivations, so no CL may take place.

Note the crucial ingredient of this account: onset consonants never receive their own mora. This claim is independently motivated, because as is shown by other sources of evidence (for example, stress and quantitative metrics), onset consonants never contribute to the weight of their syllable.

The predictions of moraic theory can be expressed more generally as a ‘‘conservation law’’:

- (64) *Moraic Conservation*
CL processes conserve mora count.

For purposes of (64), CL processes are defined as those involving lengthening and deletion or shortening as a single phonological process. Examination of the existing cases (section 5.1) shows that they all exhibit moraic conservation, though in strikingly varied ways. CL from onset deletion is predicted not to occur, because such a process would increase the mora count of the string by one. Because of Moraic Conservation, the moraic theory can maintain a maximally simple theory of CL: the representations themselves do all the work, since any rearrangement of segments with respect to moras will automatically conserve mora count.

It is worth considering Moraic Conservation in broader terms. In moraic theory, the prosodic tier plays a dual role: it allows length to be represented, and it forms the lowest relevant level of prosodic structure, serving as the basic unit for syllable weight, stress assignment, and tone. The essential claim of the theory is that segment length is not mere double association, as in X theory, but instead is closely bound up with the representation of prosody—that is, moraic structure provides a *prosodic frame* that guides the action of compensatory processes. The validity of this claim is borne out by

the principle of Moraic Conservation, and by the inertness of onsets: onsets are not represented prosodically and hence are excluded from compensatory processes.

Moraic Conservation might in principle be derivable under X theory, if we could stipulate the following: the number of weight-bearing Xs remains constant through a derivation. But a look at the derivations given above shows that this would be a highly arbitrary stipulation, for the following reason: in the course of a derivation, X slots can be converted from weight-bearing to non-weight-bearing status and vice versa. It is purely an accident under the theory that once we reach the end of the derivation, the number of weight-bearing Xs is the same as when we started.

5.3.2. *The Vowel Loss Asymmetry.* The other asymmetry in CL concerns vowel loss: deletion of a vowel can lengthen the vowel of the syllable to the right, but not to the left. As before, X theory incorrectly derives this result, via the mechanism of double flop:

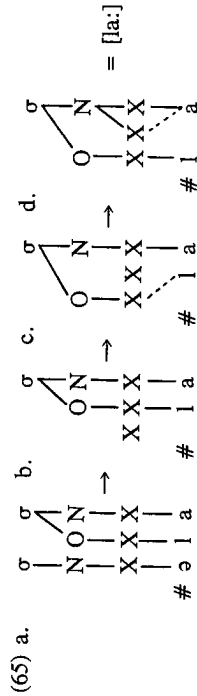

Here again, the only way to exclude these derivations would be to add principles to the theory that would constrain the inventory of possible linkages and reassociations. As before, however, such constraints are unlikely to hold, given the evidence of section 4. In particular, the flopping of a consonant segment onto a former nucleus position (as in (65c)) has precedents both in the actual vowel loss cases (section 5.1.6) and in the glide formation cases (section 4.3); and the representation of a long segment as double linking to a former onset + nucleus sequence in (65d) has a precedent in the Ilokano case (see (34b)).

Moraic theory derives vowel loss cases using Parasitic Delinking. For Middle English, this disassociates the /l/ of /tala/ from its mora, thus rendering the mora accessible to spreading from /a/ ((24)-(26)). But this mechanism is not symmetrical. If a vowel on the left is deleted, then Parasitic Delinking is not applicable:

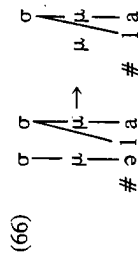

Since the /l/ remains linked, it is impossible for the following /a/ to spread leftward, due to the ban on crossing association lines.

In most cases of initial vowel deletion, the stranded mora would simply float and later be deleted by Stray Erasure. Notice, however, that where exotic distributions of geminates are allowed, there is another possibility: the /l/ could spread leftward, creating a geminate, whose moraic position would fall in a separate syllable. The examples of (56) instantiate precisely this scenario.

To make the comparison fair, we should also consider the possibility of CL through double flop. For moraic theory, CL is excluded here by the basic principle noted in section 3.2: CL may only occur when a prosodic element is stranded. Once we have finished the first flop, as in (67), there is no stranded element:

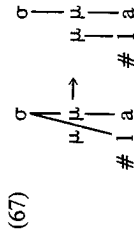

The /l/ may syllabify as the onset of the following syllable (again see (56)), but it is not possible for the vowel /a/ to lengthen.

CL through vowel loss is also subject to a number of other typological tendencies. As noted in section 4.2, vowel loss cases typically are confined to words in which the vowel to be lengthened is in an open syllable. This is predicted by the theory. If we try a derivation parallel to (24)-(26) in which the preceding syllable is closed, the following configuration results:

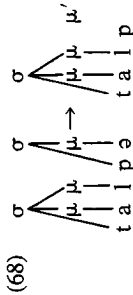

Here the /a/ cannot lengthen because of the ban on crossing association lines. In principle the /l/ could lengthen, but two factors militate against this: trimoraic syllables are rare, and consonants linked to two moras in the same syllable are likewise unusual. In Estonian, both of the aberrant configurations are permitted, and we actually do find lengthening of the consonant corresponding to /l/ in (68). Mürk (ms.) notes historical cases like Proto-West-Finnic **küilma* → Estonian *küil:m* 'cold-nom. sg.', and Prince (1980, 549) provides synchronic instances such as /*antisa*/ → [en:tsa] 'happy-gen. sg.'. Estonian is discussed further below.

CL through vowel loss is particularly interesting when it occurs in a tone language. Hock (1986, 437-438) notes that in such cases the syllable that is compensatorily lengthened often receives a contour tone, derived from the tones of the original disyllabic sequence. As Hock observes, this is just what we would expect, if we adopt the view (proposed by Hyman (1985)) that it is the mora to which tones are associated. The basic

mechanism is shown schematically in (69). Tones should be imagined on a separate tier, projecting into the page.

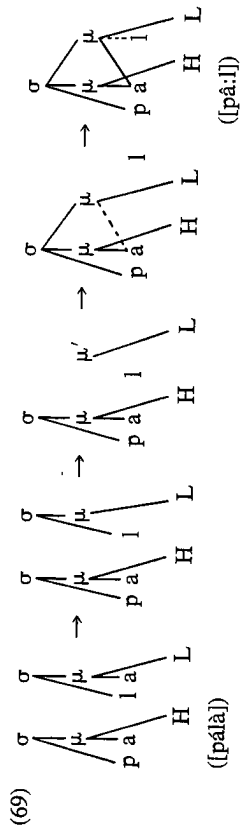

The occurrence of tone shift as a correlate of CL suggests that CL through vowel loss really does involve the migration of a mora from one syllable to another.

5.3.3. Summary. We originally considered two strategies for developing a predictive theory of CL. In X theory and its variants, explicit constraints are imposed on what can link to what, and on what double linkages represent length. In contrast, moraic theory lets the representations themselves do the work: CL is impossible in locations where the theory posits no prosodic position.

I have tried to show that the strategy adopted by moraic theory is more successful. In moraic theory, the central generalization of Moraic Conservation follows directly from the representations themselves: no stipulations about possible linkages are needed. In contrast, the X theory strategy of stipulating possible linkages is complex and arbitrary, and in fact seems to be unworkable: the cases of section 4 indicate that any constraints on possible linkages that could successfully predict Moraic Conservation would rule out actually attested cases of CL as well.

Although the moraic theory does not stipulate any principles of linking, it is subject to the general prohibition on crossed association lines. This accounts for the asymmetry in CL through vowel loss, as well as other typological observations about this kind of CL. This forms a second argument in favor of the moraic theory.

6. Language-Specific Moraic Structure and CL

De Chene and Anderson (1979) make the following cross-linguistic observation: CL appears to be possible only in languages that have a preexisting vowel length contrast. Their generalization is important for two reasons. First, as they note, it argues strongly against purely mechanical phonetic accounts of the phenomenon. Second, the task of accounting for it imposes a strong criterion of adequacy on theories of the prosodic tier.

De Chene and Anderson suggest that their observation is to be explained by placing a structure-preserving requirement on the phonologization of phonetic change: only if a language already possesses branching syllable nuclei⁷ can it reinterpret an ongoing

⁷ De Chene and Anderson use the terms *peak* and *nucleus* for what in more recent work have been called *nucleus* and *rhyme*, respectively; I use the latter terminology here.

phonetic change as a true phonological CL rule, with phonemic long vowels in the output. For example, the schematic form (70b) shows a phonetically weakened syllable-final [s], depicted as [A]. The phonetic diphthong [aA] can be phonologically reinterpreted as long [a:] (as in (70c)) only if the language allows branching nuclei.

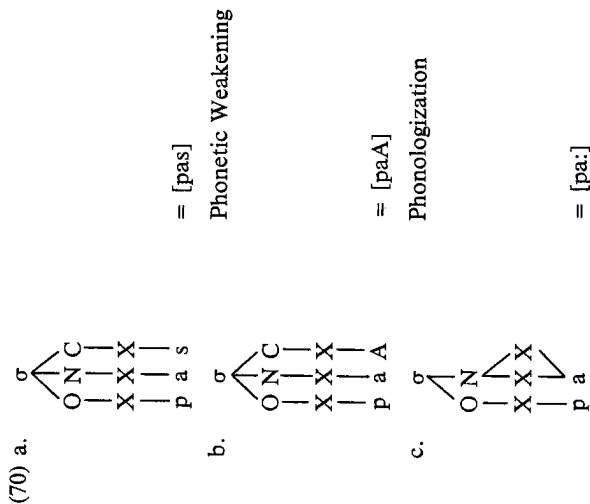

This notion of structure preservation can also be appealed to in a moraic theory, with slightly different predictions emerging. Recall the claim that moraic structure is in part language-specific. That is, in languages that lack syllable weight distinctions as well as phonemic vowel length distinctions, all syllables receive just one mora, so that a syllable like /pas/ would be represented as follows:

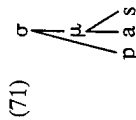

If the /s/ of this syllable is deleted, no mora will be stranded, and CL will not occur. By parallel reasoning, CL is a logical possibility in all languages that have bimoraic syllables.

For this reason, moraic theory and de Chene and Anderson's nucleus theory make different predictions. For CL to occur, the nucleus theory requires the preexistence of phonemic long vowels, whereas the moraic theory requires the preexistence of heavy syllables. The difference between the theories is in practice subtle, for the following

reason: the languages that have a vowel length contrast and the languages that have a distinction of syllable weight appear to be largely coextensive.

To distinguish the theories, we need to find the rare languages that lack a vowel length distinction but nonetheless have a distinction between monomoraic and bimoraic syllables, where the latter would take the form CVC. Such a distinction would be evident from stress rules or other prosodic phenomena. In two such languages I know of, we find CL, in accordance with the predictions of moraic theory.

Ilokano has no phonemic vowel length contrast; all surface vowel length is predictable. However, the Ilokano stress system does refer to syllable quantity, that is, to the distinction between CV and CVC syllables; for details, see Vanoverbergh (1955). Ilokano has a productive process of reduplication, which copies initial C₀YC-. When applied to stems that begin with /C₀V? . . ./, this process would be expected to place /ʔ/ in syllable-final position. However, /ʔ/ is not allowed syllable-finally, and what surfaces in these cases is a long vowel. For example, from the stem *daʔit* 'sew' we get [da:daʔit] 'is sewing'.

The most likely historical origin of this pattern is a CL rule of the following sort:

$$(72) \quad V? \rightarrow V: / \text{--- }]sy]$$

Although internal evidence suggests that CL has been reanalyzed as a phenomenon internal to the reduplication system (see Hayes and Abad (forthcoming)), the basic point remains: a language that lacks a vowel length contrast, but has a syllable weight contrast, can create surface long vowels through a process essentially equivalent to CL.

The other relevant case is provided by Hock (1986, 453), who observes that Andalusian Spanish innovated vowel length through the weakening and loss of word-final /s/. The relevance of a syllable weight contrast (CVC vs. CV) in the stress system of Spanish is well known (Harris (1983)).⁸

The upshot of this discussion is that in the rare cases where a language has a syllable weight contrast without a vowel length contrast, the weight contrast alone appears to be sufficient for CL. I take this as evidence that it is the moraic structure of a language, and not its vowel inventory, that determines whether CL may occur. De Chene and Anderson's nucleus-based proposal comes close to accounting for the facts; but this is due to the substantial overlap of the set of syllable weight languages with the set of vowel length languages.

This point is significant in evaluating moraic theory and X theory. In X theory, CVC syllables in all languages have the same structure on the prosodic tier, namely, XXX. Whether a language has a syllable weight distinction makes no difference to the representation. In contrast, moraic theory represents CVC variably, depending on whether

⁸ Roca (1988), citing borrowed forms such as *Washington* and *Róbinson*, claims that quantity is irrelevant to Spanish stress. However, as Roca admits (p. 418), these borrowings are unassimilated and tend to be regularized (*Washington*). Moreover, the generalizations based on syllable weight hold for the vast bulk of the Spanish vocabulary, and made-up forms that violate them are judged as ill-formed by native speakers (Harris (1983, 10–11)).

the language has a weight distinction. The preconditions for CL noted above indicate that the prosodic structure of the syllable does indeed vary on a language-particular basis, favoring the moraic theory over X theory and its variants.

7. Trimoraic Syllables

I have postponed to this point the question of whether the maximum number of moras per syllable is always two. We are now in a position to address this matter.

Syllable weight is usually viewed as a binary opposition; this would be expressed in moraic theory as an upper limit of two moras per syllable. No matter how many consonants we append to CVC or CVV, they are simply adjoined to the last mora, making the syllable no heavier. A two-mora limit makes interesting predictions. For instance, consonant loss in a doubly closed syllable should not result in CL. The disappearing consonant shares a mora with another consonant, so that its deletion fails to strand a mora (see McCarthy and Prince (forthcoming)):

$$(73) \quad \begin{array}{c} \sigma \\ \swarrow \quad \searrow \\ \mu \quad \mu \\ \swarrow \quad \searrow \quad \swarrow \quad \searrow \\ s \quad u \quad l \quad t \quad n \quad i \end{array} \quad \rightarrow \quad \begin{array}{c} \sigma \\ \swarrow \quad \searrow \\ \mu \quad \mu \\ \swarrow \quad \searrow \\ s \quad u \quad t \quad n \quad i \end{array}$$

Some sketchy data from Harms (1968) suggest that this outcome can in fact arise. In Komi Ižma, an Altaic language, underlying /sul.ta.li/ becomes [su:taɪ] 'I stood up', with CL from loss of /l/. But /sult.ni/ (in (73)) becomes [sutni] 'to stand up', with no CL. This difference follows immediately if we assume that Komi imposes an upper limit of two moras per syllable.

Despite this, I believe that a good case can be made that trimoraic syllables do exist, at least in some languages. The arguments are as follows.

First, cases can be found in which CL does arise in doubly closed syllables. Most of these are in word-final position, where the right results can be obtained through judicious use of extrametrical consonants. But in Proto-Germanic, the loss of [ŋ] before [x] gave rise to CL even in nonfinal doubly closed syllables (Wright and Wright (1925)), as in **θaŋxta* → *θa:xta*, Modern English *thought*. Such a change is not derivable unless we suppose that the syllable *θaŋx* was trimoraic. The derivation would be as follows:

$$(74) \quad \begin{array}{c} \sigma \\ \swarrow \quad \searrow \\ \mu \quad \mu \\ \swarrow \quad \searrow \quad \swarrow \quad \searrow \\ \theta \quad a \quad \eta \quad x \quad t \quad a \end{array} \quad \rightarrow \quad \begin{array}{c} \sigma \\ \swarrow \quad \searrow \\ \mu \quad \mu \\ \swarrow \quad \searrow \\ \theta \quad a \quad x \quad t \quad a \end{array}$$

Second, the distinctions of syllable weight referred to by stress rules sometimes require us to posit trimoraic syllables. Pandey (ms.) shows that in a dialect of Hindi superheavy syllables (CVVC, CVCC) are consistently treated differently from heavy

syllables (CVV, CVC); roughly, superheavy syllables pattern like heavy-light sequences, no matter where they occur in a word. Van der Hulst (1984) likewise argues for the relevance of trimoraic syllables in stress assignment in Dutch.

Third, a case for trimoraic syllables can be made from Persian quantitative metrics. In this system light syllables correspond to a short metrical position (/-) and heavy syllables to either a long metrical position (/-) or two shorts (/~ -). Superheavy syllables (CVVC and CVCC) are scanned as /- -/. If we make the usual assumptions for quantitative metrics (/-/ corresponds to two moras, /-/ to one), then the superheavy syllables must count as trimoraic. Interestingly, the "ultraheavy" CVVCC syllables of Persian are scanned as /- -/ as well, suggesting that an upper limit of three moras is in effect. The proposed moraic structure of Persian syllables is summarized under (75). For fuller discussion, see Elwell-Sutton (1976) and Hayes (1979).

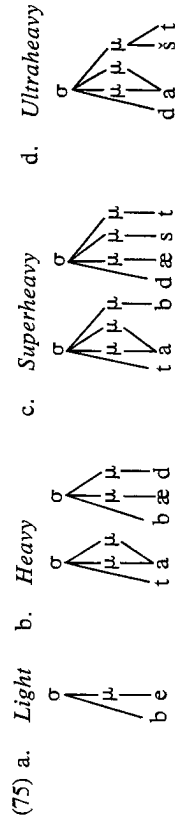

Finally, the existence of trimoraic syllables is supported by languages that have a three-way vowel length distinction. Since in moraic theory vowel length is represented by the number of moras linked to a vowel, a /V/-V/-V::/ opposition requires that /V::/ appear in a trimoraic syllable. Three-way vowel length contrasts are found in Estonian (Lehiste (1966), Prince (1980), Mürk (ms.)), as well as in various German and Danish dialects (Hock (1986)). Historically, they all appear to have arisen via CL—in particular, through vowel loss in the following syllable. Hock presents the following historical derivations for the three-way distinction in the Dithmarschen/Stavenhagen dialect of German:

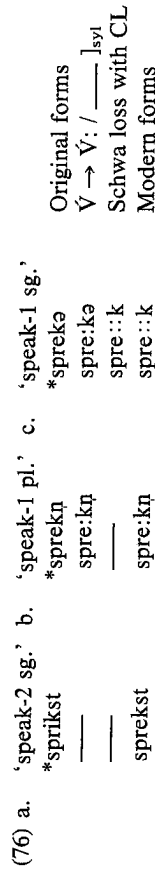

The shift from *spre:kə* to *spre::k* would be treated as follows by the mechanisms of section 4.2:

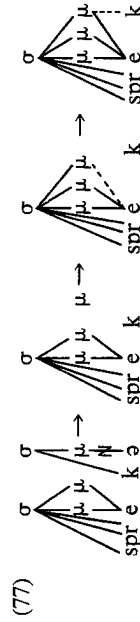

To summarize, the existence of trimoraic syllables is supported by CL in doubly closed syllables, by Hindi and Dutch stress, by Persian metrics, and by triple vowel length distinctions. The overriding generalization seems to be that although onset consonants cannot make weight, coda segments can, even when this boosts the mora population of the syllable above two.

8. Earlier Accounts of CL

8.1. Hock (1986)

To my knowledge the first wide-ranging study of the relevance of moras to CL is that of Hock (1986), and the debt of this article to his is substantial. In this section I discuss the specifics of Hock's account.

Hock's idea is to adopt a moraic tier, but to retain a segmental prosodic tier as well, for which he employs CV theory. The following derivation, adapted from Hock's example (39), shows how he would derive a case of CL from vowel loss:

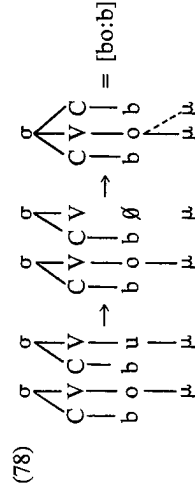

Though I agree with the spirit of Hock's proposal, the actual mechanism is subject to two objections. First, it appears that Hock's account multiplies entities unnecessarily, since we do not need a segmental prosodic tier if we have a moraic tier. Second, since Hock's theory includes the largest amount of theoretical apparatus, it is capable of deriving the largest number of possible outcomes—and thus makes the weakest and least interesting empirical predictions. For example, it allows for bimoraic short vowels, monomoraic long vowels, and moraic onset consonants. Given this, I feel that Hock's theory should not be adopted unless further data are presented that force us to do so.

8.2. Metrical CL

In section 7 I suggested that overlong vowels necessitate trimoraic syllables. This account must be considered in comparison with a cogent alternative—namely, the metrical approach to overlength originally proposed for Estonian by Prince (1980). The core of Prince's proposal is this: a metrical foot has some minimum phonetic duration. Normally, this duration is distributed over two syllables, but in the case of overlength there is a monosyllabic foot, so that all of the duration is awarded to a single syllable. It is the interaction of this additional metrically based duration and a normal binary vowel length distinction that yields the surface three-way opposition:

- (79) a. Short [CV CV]_F b. Long [CVV CV]_F c. Overlong [CVV]_F CV

More recently Minkova (1985) and Prince (1987) have proposed that CL itself can be metrical rather than moraic: a segment is lost, but the durational content of the foot it occupied is preserved. In this section I will present some reasons for favoring the moraic over the metrical approach.

8.2.1. *Scope of the Theories.* As Prince (1987) observes, the metrical account is unlikely to be a complete theory of CL. In particular, many CL varieties (see sections 5.1.1, 5.1.3, 5.1.4, 5.1.5) are found in languages that lack stress and thus arguably lack metrical structure. The vowel loss type (section 5.1.6) is indeed usually found in stress languages and usually affects only stressed vowels, as the metrical account predicts. In Hungarian, however, the vowels affected by CL are not always stressed (Kaiman (1972)), making a metrical account dubious. Note that the characteristic appearance of vowel loss cases in stress languages is to be expected in any event: vowel loss happens more often in stress languages, and a stressed vowel is typologically more likely than a stressless vowel to reinforce itself by picking up a stray mora.

8.2.2. *Overlength Contrasts in Monosyllables.* An apparent advantage of the metrical account is that it predicts correctly that all Estonian monosyllables should have overlength, since a monosyllabic word is necessarily a monosyllabic foot (Prince (1980, 535)). The moraic account makes no such prediction. But this argument cuts both ways, because it involves a language-particular fact of Estonian. The German dialects with overlength freely contrast long and overlong vowels in monosyllables: compare *hu:s* 'house-nom.' with *hu::s* 'house-dat.', where the latter is historically descended from **hu:sə* (data from Dithmarschen/Stavenhagen, Hoek (1986)). If it is an advantage that the metrical account inexorably places overlength on Estonian monosyllables, then surely it is a great disadvantage that it necessarily places overlength on all monosyllables in the German dialects, contrary to fact. The Estonian data may simply reflect an earlier near-prohibition on monosyllables at the stage prior to the vowel loss that created overlength (Mürk (ms.)). The moraic account should be favored, since it makes overlength on monosyllables a contingent fact, not a necessary one.

8.2.3. *Gemination Alternations in Estonian.* One aspect of Estonian phonology is considerably simplified under a moraic account. Prince (1980) notes the following pattern: when the morphological grade alternation involves a shift between syllables in the second and third degrees of quantity (Q2 and Q3), Q2 syllables show a loss of gemination under certain circumstances. This loss renders them prosodically equivalent to other Q2 forms that lack geminates underlyingly:

(80) *Loss of Gemination and Overlength* *Loss of Overlength Only*

	<i>Strong Grade</i> (Q3)	<i>Weak Grade</i> (Q2)	<i>Strong Grade</i> (Q3)	<i>Weak Grade</i> (Q2)
a.	paat:ti 'boat-ill. sg.'	paati 'gen. sg.'	kaa:lu 'weight-part. sg.'	kaalu 'gen. sg.'
b.	poi:s:si 'boy-part. sg.'	poisi 'gen. sg.'	tei:se 'other-ill. sg.'	teise 'gen. sg.'
c.	tark:ka 'wise-part. sg.'	tarka 'gen. sg.'	tan:ki 'tongs-part. sg.'	tanki 'gen. sg.'

Loss of gemination is not a general concomitant of the weak grade. When a strong grade geminate is preceded by just a single short vowel in its syllable, then it persists in the weak grade form:

- (81) Strong (Q3): pat:tu 'sin-part. sg.'
Weak (Q2): pattu 'gen. sg.' (*patu)

For this reason Prince adds a phonological rule to remove the overlength in the weak grade in the appropriate environments. The rule refers to the metrical foot (F) and is stated as follows:

- (82) *Prosodic Degemination* (Prince (1980, 539))
 $C_i C_i \rightarrow C_i / [F \dots V [+seg] \text{---} V \dots]$

My claim is that under a moraic analysis, this fairly complex rule is not necessary. Under the most straightforward moraic interpretation of the facts, the loss of gemination is a direct consequence of the shift in syllable quantity. I adopt the following assumptions: syllables in Q3 have three moras, syllables in Q2 have two moras, and syllables in Q1 (only CV is possible) have one mora. For certain syllables this means that the segments group more than one to a mora, but for any given syllable type enough moras are present to represent the possible length contrasts.

For those morphological environments in which the grade alternation is manifested by overlength, I posit the following rule:

- (83) To go from strong grade to weak grade, remove the third mora.

This is simply the moraic expression of the quantity shift, corresponding to Prince's "Basic Grade Principle" (1980, 538). The advantage of expressing the rule moraicly is that it automatically eliminates gemination in the appropriate forms, as the following derivations show:

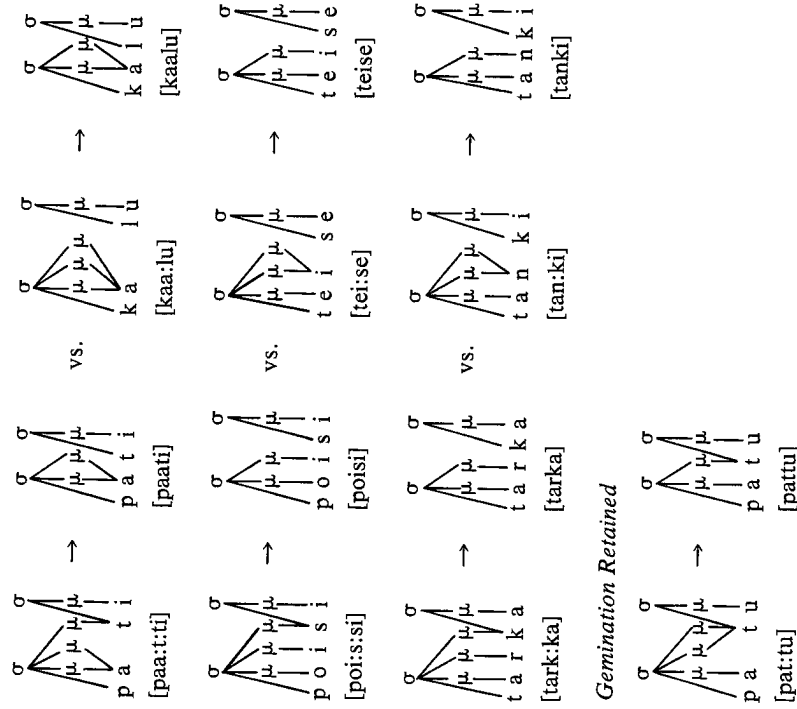
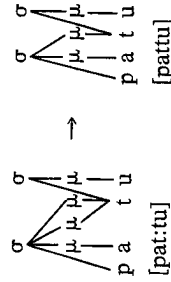
(84) a. *Gemination Lost*b. *Gemination Retained*

- (85) [aa:] in [kaa:ta] (3 moras) 243 msec
 [aa:] in [kaa:t:ta] (2 moras) 183 msec
 [aa] in [kaata] (2 moras) 196 msec

[t:t] in [kat:ta]	(2 moras + onset)	221 msec
[t:t] in [kaa:t:ta]	(1 mora + onset)	202 msec
[tt] in [katta]	(1 mora + onset)	151 msec
[s:] in [kas:ta]:	(2 moras)	131 msec
[s:] in [kaa:s:ta]	(1 mora)	72 msec
[s] in [kasta]	(1 mora)	98 msec

The general picture that emerges from Ojamaa's data is that although no account lets us read durations directly off the phonological representation, the moraic theory comes somewhat closer to the phonetic facts than the traditional transcriptions do. The same conclusion can be drawn from Lehiste's (1966) consonant duration measurements.

8.2.4. Summary. The arguments of this section were as follows: the moraic theory provides a better account of the loss of gemination in Estonian, and also a more adequate account of the German cases, where the crucial prediction of the metrical theory concerning monosyllables fails. Further, the metrical theory is not comprehensive enough to encompass all cases of CL, in that some arise in a manner completely independent of stress and thus of metrical structure.

It is easy to imagine data that would decide conclusively between the metrical and moraic accounts. In a language where feet are labeled *ws*, the metrical theory predicts that loss of stressless vowels could lengthen the vowel to the right of the vowel that deletes. The moraic theory is indifferent to metrical structure and derives right-to-left CL for *ws* languages in the same way that it does for *sw* stress languages. Unfortunately, I know of no *ws* languages in which CL is triggered by vowel loss, and thus I cannot test these predictions.

9. Conclusions

The central claim I have argued for is that CL is not a random collection of temporal compensations for segment loss. Rather, it operates in lawful fashion, respecting prosodic structure in a way that is correctly characterized by moraic theory. There are two crucial phenomena: (a) CL does not compensate for segments lost from onset position. Since onset consonants do not make weight, they are not assigned prosodic positions in moraic theory, and thus do not induce temporal compensation when they are lost. (b) CL is confined to languages that have a syllable weight contrast. Moraic theory explains this by making prosodic structure partly language specific: only languages with a syllable weight distinction have bimoraic syllables; hence, only such languages can have CL.

X theory (as well as its variants) is singularly unsuited to describing these patterns. It assigns the same prosodic structure to identical sequences across languages, irrespective of the presence or absence of a syllable weight contrast. Thus it is unable to explain why CL occurs only when there is a preexisting syllable weight distinction. Moreover, X theory assigns every segment in the string its own prosodic position, including onset segments. It thus fails to explain why onset segments do not induce tem-

The ability to derive the pattern of gemination loss as an automatic consequence of the loss of overlength seems a clear advantage of the moraic analysis.

The analysis may appear to derive its advantage by ignoring the phonetic facts. For example, the [aa:] of *kaa:lu* is linked to three moras, whereas the [aa:] of [paa:t:ti] is linked to two. Similarly, the [t:t] of [pat:tu] is linked to two moras, the [t:t] of [paa:t:ti] to one. But the phonetic facts may be closer to what the moraic analysis predicts than to what the standard transcription says. Ojamaa's (1976) comparative measurements show the following results, among others:

poral compensation when they are lost. One might attempt to recover the missing prediction by placing constraints on what segments may associate with what positions in the syllable. As I have tried to show, however, when X theory is applied to the more exotic types of CL, such constraints prove to be untenable; the situation comes close to one in which anything can link to anything. Once this is admitted, the claim of X theory is essentially that any segment can lengthen to compensate for the disappearance of any other segment. This is clearly the wrong prediction to make.

I have also discussed a less well studied type of CL, in which the loss of a vowel leads to CL in the preceding syllable. The proposed mechanism for this is Parasitic Delinking, whereby vowel loss induces loss of syllable structure, rendering a stray mora accessible to the preceding syllable. This mechanism makes a general prediction: when a stranded mora moves to a different syllable on the surface, such movement must always be to the left, since rightward movement would violate the ban on crossed association lines. All the cases of transsyllabic movement I have found so far (the vowel loss cases, Ilokano, and *Managerial* Lengthening) involve movement to the left.

Finally, I have suggested that a number of phenomena support the existence of trimoraic syllables. In the best-studied case, Estonian, it appears that a trimoraic account offers substantial advantages over the alternative metrical analysis.

Appendix: Further Issues in Moraic Theory

The main body of this article focuses on issues of CL. However, moraic theory has many consequences elsewhere in phonology, and a fair comparison of theories requires us to consider whether there are any significant results that can be obtained under segmental prosodic theories that cannot be obtained under moraic theory. My own view is that this is not the case, and I will try to support this view in the following discussion.

A1. Onsets and Rhymes

The version of moraic theory I have adopted posits that the syllable contains no onset or rhyme constituents, and it must therefore provide an alternative account of the evidence that has been presented in the literature in favor of onsets and rhymes. I believe that although this evidence involves genuine and significant cross-linguistic generalizations, it is not necessarily best interpreted as requiring onset/rhyme constituency. The three most significant arguments are as follows.

First, the rhyme is supported by its ability to express syllable weight distinctions, as branching versus nonbranching. This clearly does not distinguish between theories, as moraic theory can express the same distinction with mora count.

A second argument is discussed by Harris (1983) and Steriade (1988): many phonological rules (such as English /r/ Dropping, Cuban Spanish /n/ Velarization) are difficult to characterize in linear terms or with a structureless syllable but can be straightforwardly described as applying to segments within the rhyme. The observation seems valid, but as Donca Steriade (personal communication) has suggested to me, the relevant

distinctions can be reconstructed in moraic theory. If we assume that onset consonants depend directly from the syllable node (McCarthy and Prince (forthcoming)), rather than from the first mora (Hyman (1985)), then the notion of 'rhyme-internal segment' can be reformulated as 'segment dominated by μ .' Steriade points out that this offers an additional theory-internal advantage: we can state that in the unmarked case association of moras and segments is one-to-one.

A third argument for onsets and rhymes is based on the fact that cooccurrence restrictions on segments within the syllable are typically confined to onset-internal sequences and rhyme-internal sequences; that is, in the normal case a well-formed onset plus a well-formed rhyme equals a well-formed syllable. Though this is not a universal, it is defended as a strong tendency by Fudge (1987).

This generalization can also be characterized without the use of the rhyme: such constraints characteristically are constraints on total syllable weight, and thus are aptly stated moraicly. For example, in Hausa and many other languages the possible syllables are CV, CVV, and CVC; *CVVC and *CVCC are excluded. This could be described as involving an upper limit on rhyme length of two segments. But it could equally be characterized as a limit of two moras per syllable and one segment per mora. Similarly, the well-known English constraint that allows /paynt/, but not */paymp/ and */paypk/ (Fudge (1987, 369)), can also be stated moraicly: the upper limit on moras is two, and only coronals may occur after the second segment of a mora.

It remains to be seen whether there is a true asymmetry in vowel-onset versus vowel-coda dependencies, not based on weight, which would motivate onset and rhyme constituents.

McCarthy and Prince (forthcoming) discuss these and other issues, such as language games said to involve movement of the onset. In no case does there appear to be compelling evidence for onset/rhyme constituency. I differ from McCarthy and Prince only in explicitly rejecting the possibility of grouping consonants under onset or coda nodes. Such nodes could in principle count as prosodic positions, which, as I have shown, must be avoided.

A2. Contour Segments

Affricates and other contour segments are sequential in featural content but phonologically monosegmental. Segmental prosodic theories represent them as segment sequences linked to a single slot. For example, Clements and Keyser (1983, 35) represent the distinction between Polish /tʃi/ 'whether' and /tʃi/ 'three' as in (86):

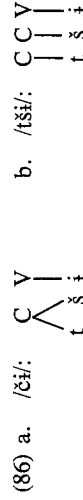

Since moraic theory posits no prosodic slots for onset segments, it is incompatible with this account.

However, as McCarthy and Prince (forthcoming) point out, moraic theory is compatible with an alternative representation for affricates proposed by Sagey (1986, 49–52): an affricate involves sequential branching for the feature [continuant], within a tree model of segment structure of the kind proposed in Clements (1985). Sagey and McCarthy and Prince argue that such a representation is to be preferred on independent grounds to the representation of (86a). I will not repeat their discussion here.

A3. /yi/ and /wu/

Under normal assumptions, syllables beginning with /yi/ and /wu/ are not easy to represent under the version of moraic theory I am proposing. Although such syllables are missing from many languages (Kawasaki (1982)), they are not so rare as to be exotic. The most obvious way of representing such syllables in moraic theory would be as in (87):

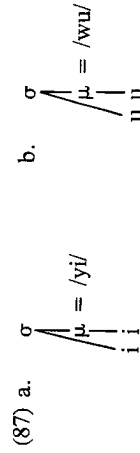

But the representations of (87) violate the Obligatory Contour Principle (OCP), a principle that, although controversial (Odden (1986a; 1988)), does a great deal of work in nonlinear phonology; see McCarthy (1986) and much other work.

Another possibility, suggested by McCarthy and Prince (forthcoming), is as in (88):

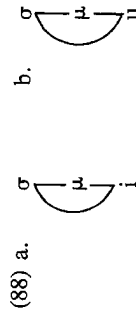

The difficulty with this proposal, as Janeway (1987) has pointed out, is that it necessitates placing actual syllable structure in underlying forms, to distinguish /yi/ from /i/ and /wu/ from /u/. As noted earlier, there is good reason to place only moraic structure, not syllable structure, in underlying forms, in order to derive the cross-linguistic generalization that syllable division is always predictable. Adopting (88) would destroy this prediction.

The best answer, I believe, is to adopt Hyman's (1985) suggestion that, at least in some languages, glides differ from vowels in being [+consonantal] rather than [−consonantal]. Such a featural difference would allow us to represent /yi/ and /wu/ without violating the OCP:

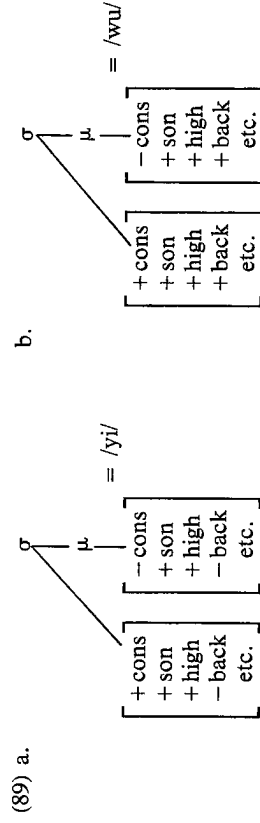

The (rather numerous) languages in which /yi/ and /wu/ are ill-formed represent /y/ and /w/ as [−consonantal], thus ruling out /yi/ and /wu/ by the OCP.

Phonetic observation, at least of English, supports Hyman's suggestion. In the pronunciations of English *ye* and *woo* I have observed, /y/ and /w/ have considerably greater constriction than the following vowel, suggesting they are phonologically less sonorous.

In Central Alaskan Yupik glides actually contrast with vowels when they occur in coda position, as in surface minimal pairs such as (90) (Woodbury (1987, 687)):

- (90) a. [ányalɪ:yulú:ni] 'he was excellent at making boats'
 b. [ányalɪyyulú:ni] 'he was EXCELLENT at making boats'

Coda consonants in this language are arguably mora-bearing; hence the contrast can be depicted only if glides and high vowels are featurally distinct:

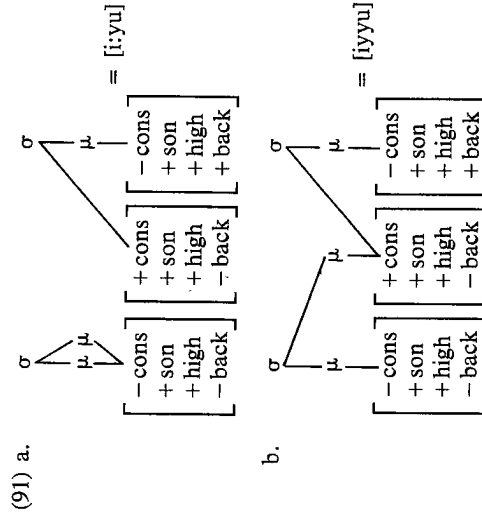

As Hyman (1985) points out, in Semitic languages glides may appear in consonantal

roots, most dramatically in the root /y/ *yayay* 'to write the letter y' (McCarthy (1981, 396)). Representing Semitic glides as [+consonantal] can solve the long-standing problem of how to indicate that they are to be mapped onto syllable-peripheral rather than nuclear positions.

To conclude: there is evidence that at least some glides are not the same thing as nonsyllabic high vowels, being featurally distinct from them. A prediction of the moraic theory adopted here is that the /y/ and /w/ of /yi/ and /wu/ will normally pattern as featurally distinct from /i/ and /u/, and not as nonsyllabic vowel segments.

A4. Syllable-Initial Geminates

The theory of moraic phonology provides no straightforward way to represent a syllable-initial geminate. This is arguably the right prediction to make on a typological basis; the great majority of geminates across languages are divided between syllables. For the remaining cases, there are a number of possible accounts. In many instances one can argue that the first half of the geminate is actually a separate syllable, as in (92):

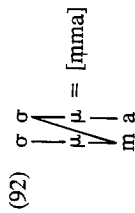

This appears to be the correct representation for Luganda, where the first half of a geminate (even an obstruent) is tone-bearing (Clements (1986)). It also appears to be correct for Ponapean (McCarthy and Prince (forthcoming)).

Another possibility is that syllable-initial geminates have two segmental positions, as in (93):

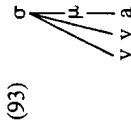

This is a plausible account for Russian, where such geminates arise through the deletion of *jer* vowels. In some dialects of Russian (Jones and Ward (1969)) syllable-initial [ʃ, ʒ] arises by simplification of /ʃʃ/, which would yield the same structure.

This account violates the OCP, but this seems less reason to reject it than for (87). The reason is that the OCP violations are derived by morpheme concatenation or by phonological rule, and are not underlying. The evidence in favor of the OCP seems considerably stronger for underlying representations than for derived forms.

A third possibility is to allow a stray mora to occur extrasyllabically, as in (94):

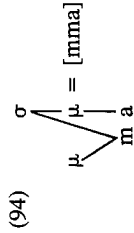

Such a configuration would be expected to occur only word-initially, as word-peripheral position is characteristic of extrasyllabic elements (Steriade (1982), Itô (1986)). Restriction to word-initial position does appear to be a typical property of syllable-initial geminates cross-linguistically.

The upshot is that moraic theory provides straightforward representations for geminates in their usual, intervocalic position. The locations where the theory forces us to consider more marked analytical alternatives are precisely the locations where geminates are uncommon across languages.

Both syllable-initial geminates and the case of /yi/ and /wu/ raise a general question about the evaluation of theories. In describing these configurations, moraic theory faces some awkwardness in comparison to segmental prosodic theories. Yet these configurations are demonstrably marked, being avoided in numerous languages. The compensation for the descriptive awkwardness of moraic theory is that it can be interpreted as directly reflecting the markedness of the relevant configurations. In contrast, segmental prosodic theory says nothing about why so many languages should avoid /yi/, /wu/, and syllable-initial geminates. I believe that the ability of moraic theory to account for widespread patterns of markedness should be given more weight in assessing the evidence than any particular awkwardness in the analysis of individual languages.

References

- Abraham, R. C. (1951) *The Idoma Language*, Idoma Native Administration, Nigeria.
 Allen, W. S. (1973) *Accent and Rhythm*, Cambridge University Press, Cambridge.
 Bichakjian, B. (1986) "When Do Lengthened Vowels Become Long? Evidence from Latin and French," in L. Wetzels and E. Sezer, eds. (1986).
 Campbell, A. (1959) *Old English Grammar*, Oxford University Press, London.
 Chomsky, N. and M. Halle (1968) *The Sound Pattern of English*, Harper and Row, New York.
 Clements, G. N. (1985) "The Geometry of Phonological Features," *Phonology Yearbook* 2, 225-252.
 Clements, G. N. (1986) "Compensatory Lengthening and Consonant Gemination in Luganda," in L. Wetzels and E. Sezer, eds. (1986).
 Clements, G. N. and S. J. Keyser (1983) *CV Phonology*, MIT Press, Cambridge, Massachusetts.
 Constantino, E. (1971) *Ilokano Reference Grammar*, University of Hawaii Press, Honolulu.
 de Chene, E. B. (1979) *The Historical Phonology of Vowel Length*, Doctoral dissertation, UCLA, Los Angeles, California.
 de Chene, E. B. (1987) "Compensatory Lengthening as Assimilation," paper presented at the 1987 meeting of the Linguistic Society of America, San Francisco.
 de Chene, E. B. and S. R. Anderson (1979) "Compensatory Lengthening," *Language* 55, 505-535.

- Davis, S. (1985) *Topics in Syllable Geometry*, Doctoral dissertation, University of Arizona, Tucson. [Forthcoming, Garland Press, New York.]
- Dell, F. and M. Elmedlaoui (1985) "Syllabic Consonants and Syllabification in Imdlawn Tashlhiyt Berber," *Journal of African Languages and Linguistics* 7, 105-130.
- Donegan, P. and D. Stampe (1982) "The Syllable in Phonological and Prosodic Structure," in A. Bell and J. Hooper, eds., *Syllables and Segments*, North-Holland, Amsterdam.
- Dresher, E. (1985) "Constraints on Empty Positions in Tiered Phonology," ms., Department of Linguistics, University of Toronto.
- Elwell-Sutton, L. P. (1976) *The Persian Meters*, Cambridge University Press, Cambridge.
- Fudge, E. C. (1987) "Branching Structure within the Syllable," *Journal of Linguistics* 23, 359-377.
- Guerssel, M. (1986) "Glides in Berber and Syllabicity," *Linguistic Inquiry* 17, 1-12.
- Hale, K. (1973) "Deep-Surface Canonical Disparities in Relation to Analysis and Change," in T. Sebeok, ed., *Current Trends in Linguistics*, vol. 11, Mouton, The Hague.
- Harms, R. (1968) *Introduction to Phonological Theory*, Prentice-Hall, Englewood Cliffs, New Jersey.
- Harris, J. (1983) *Syllable Structure and Stress in Spanish*, MIT Press, Cambridge, Massachusetts.
- Harris, J. (1987) "Sonority and Syllabification in Spanish," ms., Department of Linguistics and Philosophy, MIT, Cambridge, Massachusetts.
- Hayes, B. (1979) "The Rhythmic Structure of Persian Verse," *Edabiyat* 4, 193-242.
- Hayes, B. (1982) "Extrametricity and English Stress," *Linguistic Inquiry* 13, 227-276.
- Hayes, B. and M. Abad (forthcoming) "Reduplication and Syllabification in Ilokano," to appear in *Lingua*.
- Hock, H. (1986) "Compensatory Lengthening: In Defense of the Concept 'Mora'," *Folia Linguistica* 20, 431-460.
- Hyman, L. (1984) "On the Weightlessness of Syllable Onsets," in C. Brugman and M. Macaulay, eds., *Proceedings of the Tenth Annual Meeting of the Berkeley Linguistics Society*, University of California, Berkeley.
- Hyman, L. (1985) *A Theory of Phonological Weight*, Foris, Dordrecht.
- Ingria, R. (1980) "Compensatory Lengthening as a Metrical Phenomenon," *Linguistic Inquiry* 11, 465-495.
- Itô, J. (1986) *Syllable Theory in Prosodic Phonology*, Doctoral dissertation, University of Massachusetts, Amherst.
- Janeway, R. (1987) "Luganda in Moraic Theory," ms., Department of Linguistics, UCLA, Los Angeles, California.
- Jensen, J. (1977) *Yapese Reference Grammar*, University of Hawaii Press, Honolulu.
- Jespersen, O. (1909) *A Modern English Grammar on Historical Principles, Part I: Sounds and Spellings*, George Allen & Unwin, London.
- Jones, D. and D. Ward (1969) *The Phonetics of Russian*, Cambridge University Press, Cambridge.
- Kalman, B. (1972) "Hungarian Historical Phonology," in L. Benkó and S. Imre, eds., *The Hungarian Language*, Akadémiai Kiadó, Budapest.
- Kawasaki, H. (1982) *An Acoustical Basis for Universal Constraints on Sound Sequences*, Doctoral dissertation, University of California, Berkeley.
- Lehiste, I. (1966) *Consonant Quantity and Phonological Units in Estonian*, Mouton, The Hague.
- Levin, J. (1985) *A Metrical Theory of Syllabicity*, Doctoral dissertation, MIT, Cambridge, Massachusetts.
- Lowenstamm, J. and J. Kaye (1986) "Compensatory Lengthening in Tiberian Hebrew," in L. Wetzels and E. Sezer, eds. (1986).
- Luick, K. (1907) "Beiträge zur englischen Grammatik V: zur Quantifizierung der romanischen Lehnwörter und den Quantitätsgesetzen überhaupt," *Anglia* 29, 1-55.
- McCarthy, J. (1979) *Formal Problems in Semitic Phonology and Morphology*, Doctoral dissertation, MIT, Cambridge, Massachusetts. [Available from Indiana University Linguistics Club, Bloomington.]
- McCarthy, J. (1981) "A Prosodic Theory of Nonconcatenative Morphology," *Linguistic Inquiry* 12, 373-418.
- McCarthy, J. (1986) "OCP Effects: Gemination and Antigeminant," *Linguistic Inquiry* 17, 207-263.
- McCarthy, J. and A. Prince (forthcoming) "Prosodic Morphology," ms., University of Massachusetts, Amherst, and Brandeis University, Waltham, Massachusetts.
- Michelson, K. (1986) "Ghost R's in Onondaga: An Autosegmental Analysis of *R-stems," in L. Wetzels and E. Sezer, eds. (1986).
- Minkova, D. (1982) "The Environment for Open Syllable Lengthening in Middle English," *Folia Linguistica Historica*, 3, 29-58.
- Minkova, D. (1985) "Of Rhyme and Reason: Some Foot-Governed Quantity Changes in English," in R. Eaton et al., eds., *Papers from the Fourth International Conference on English Historical Linguistics*, John Benjamins, Amsterdam.
- Mitk, H. (ms.) "The Grade Alternation System in Estonian Morphophonology," ms., Department of Linguistics, University of Toronto.
- Murray, R. and T. Vennemann (1983) "Sound Change and Syllable Structure in Germanic Phonology," *Language* 59, 514-528.
- Newton, B. (1972) *The Generative Interpretation of Dialect: A Study of Modern Greek Phonology*, Cambridge University Press, Cambridge.
- Odden, D. (1986a) "On the Role of the Obligatory Contour Principle in Phonological Theory," *Language* 62, 353-383.
- Odden, D. (1986b) Review of Hyman (1985), *Language* 62, 669-673.
- Odden, D. (1981) "A Nonlinear Approach to Vowel Length in Kimatuumbi," ms., Ohio State University, Columbus.
- Odden, D. (1988) "Anti Antigeminant and the OCP," *Linguistic Inquiry* 19, 451-475.
- Ojamaa, K. (1976) *Temporal Aspects of Phonological Quantity in Estonian*, Doctoral dissertation, University of Connecticut, Storrs.
- Pandey, P. (ms.) "Word Accentuation in Hindi," ms., Department of Linguistics, South Gujarat University, Surat, India.
- Poser, W. (1986) "Japanese Evidence Bearing on the Compensatory Lengthening Controversy," in L. Wetzels and E. Sezer, eds. (1986).
- Prince, A. (1980) "A Metrical Theory for Estonian Quantity," *Linguistic Inquiry* 11, 511-562.
- Prince, A. (1987) "Prosodic Constraints on Compensatory Lengthening," paper presented at the First Conference on Laboratory Phonology, Columbus, Ohio. [To appear in conference proceedings.]
- Repetti, L. (ms.) "Compensatory Lengthening in Friulian," ms., Program in Romance Linguistics, UCLA, Los Angeles, California.
- Rialland, A. (1986) "Schwa et syllabes en français," in L. Wetzels and E. Sezer, eds. (1986).
- Roca, I. (1988) "Theoretical Implications of Spanish Word Stress," *Linguistic Inquiry* 19, 393-423.
- Sagey, E. (1986) *The Representation of Features and Relations in Nonlinear Phonology*, Doctoral dissertation, MIT, Cambridge, Massachusetts.
- Sezer, E. (1986) "An Autosegmental Analysis of Compensatory Lengthening in Turkish," in L. Wetzels and E. Sezer, eds. (1986).

- Steriade, D. (1982) *Greek Prosodies and the Nature of Syllabification*, Doctoral dissertation, MIT, Cambridge, Massachusetts.
- Steriade, D. (1988) "Review Article: Clements and Keyser, *CV Phonology*," *Language* 64, 118-129.
- Timberlake, A. (1983a) "Compensatory Lengthening in Slavic, 1: Conditions and Dialect Geography," in D. Worth and V. Markov, eds., *From Los Angeles to Kiev*, Slavica, Columbus, Ohio.
- Timberlake, A. (1983b) "Compensatory Lengthening in Slavic, 2: Phonetic Reconstruction," in M. Flier, ed., *American Contributions to the Ninth International Congress of Slavists*, Slavica, Columbus, Ohio.
- Trutenu, H. M. J. (1972) "Synchronic/Diachronic Variation of the Type /CV₁V₁/ ~ /C1V₁/ in the Ga Language," in *Proceedings of the Seventh International Congress of Phonetic Sciences*, Montreal, Mouton, The Hague.
- van der Hulst, H. (1984) *Syllable Structure and Stress in Dutch*, Foris, Dordrecht.
- Vanoverbergh, M. (1955) *Iloko Grammar*, Cellar Book Shop, Detroit.
- Wetzels, L. (1986) "Phonological Timing in Ancient Greek," in L. Wetzels and E. Sezer, eds. (1986).
- Wetzels, L. and E. Sezer, eds. (1986) *Studies in Compensatory Lengthening*, Foris, Dordrecht.
- Wilkinson, K. (1988) "Prosodic Structure and Lardil Phonology," *Linguistic Inquiry* 19, 325-334.
- Woodbury, A. (1987) "Meaningful Phonological Processes: A Consideration of Central Alaskan Yupik Eskimo Prosody," *Language* 63, 685-740.
- Woodbury, H. (1981) "The Loss of a Phoneme," *International Journal of American Linguistics* 47, 103-120.
- Wright, J. and M. Wright (1925) *Old English Grammar*, 3rd ed., Oxford University Press, London.

Department of Linguistics
UCLA
Los Angeles, California 90024-1543