

Bruce Hayes

Assimilation as Spreading in Toba Batak

In the phonological theory of *SPE* (Chomsky and Halle (1968)) the term "assimilation" is taken literally: one segment is altered in its feature values so as to become more similar to a nearby segment. The theory of autosegmental phonology (Goldsmith (1976; 1979)) offers a very different conception: assimilation may be expressed by *spreading rules*, which expand the temporal domain of autosegments by adding association lines, often deleting displaced autosegments in the process. Although feature-changing rules and spreading rules overlap in their empirical coverage, they are conceptually quite different. In a number of cases it has been possible to argue for the superiority of autosegmental accounts.

At present it seems worthwhile to develop a theory in which spreading is the sole mechanism of assimilation. Autosegmental theory lends itself naturally to substantive constraints on assimilation rules, hence to a more predictive framework. In contrast, feature-changing rules are hard to constrain in a principled fashion. Indeed, in the *SPE* account assimilation rules are not formally distinct from any other rules, and it is essentially accidental that languages should favor assimilations in the first place.

A great deal of work remains, however, in translating the autosegmental research program into a well-supported theory, comparable in generality to the *SPE* account. Research on autosegmental tone is well advanced and comprises a very large literature. The autosegmental subtheory of "CV phonology" is also well supported; see the work of McCarthy (1979; 1981b), Halle and Vergnaud (1980), Schein (1981), Kenstowicz (1982), Steriade (1982), Clements and Keyser (1983), Steriade and Schein (forthcoming), and others. However, in its "classical" form CV phonology permits the expression only of total, not partial, assimilation rules. The relevant mechanism is shown in (1) with a rule that takes /nt/ to [tt]:

I would like to thank G. N. Clements, Larry Hyman, Patricia Keating, W. Keith Percival, and an anonymous *Linguistic Inquiry* reviewer for their advice and comments on an earlier version of this article. None of them should be held responsible for shortcomings. Thanks also to Susanna Cumming for introducing me to the Batak facts. Some of the data reported here were first elicited by Cumming and her colleagues in a UCLA field methods class. I have checked all borrowed examples on my own and take responsibility for their accuracy. Finally, I thank my consultant Wilson Manik for his helpfulness and patience.

This research was supported in part by NSF Grant No. BNS-8418580.

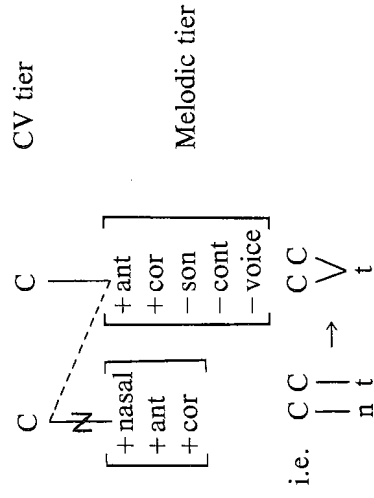
(1) *intl* → [tt] in CV Theory

A fully general autosegmental theory will have to express the much larger class of partial assimilation rules, in which only a subset of a segment's features undergoes spreading. Although some progress has been made in developing such a theory (see Goldsmith (1979; 1981), Steriade (1982), Tuller (1984), Clements (1985), Steriade and Schein (forthcoming), and other work), the issues involved are not settled; indeed, the field is arguably still in the stage of determining what the most interesting questions are.

This article has three goals. First, I will outline some of the questions that arise in developing a fully autosegmental theory. Second, I will provide evidence to bear on these questions by autosegmentally analyzing a fairly complex set of assimilation rules, most of which are rules of partial assimilation. My data are from Toba Batak, an Austronesian language spoken in northern Sumatra. Finally, I will show that the Batak data support proposals made in the literature (Steriade and Schein (forthcoming), Hayes (1986)) for explaining the "Inalterability" phenomenon—that is, the commonplace resistance of doubly linked autosegmental matrices to rule application.

The article is organized as follows. First, I will briefly review the diagnostics that can be used to determine when an assimilation is due to spreading. Second, I will present an outline theory of partial assimilation in CV phonology. Third, I will apply the theory to the facts of Toba Batak and develop the theoretical consequences of the analysis.

1. Diagnostics for Assimilation as Spreading

Recent research in CV theory (see Schein (1981), Kenstowicz (1982), Steriade (1982), Steriade and Schein (forthcoming), Hayes (1986), and other work) has provided a number of ways to determine that an assimilation is due to spreading. I will review two of these diagnostics here.

The basis of the diagnostics is this: in the case of geminate consonants and long vowels, CV phonology provides two representations for the same phonetic sequence. For example, a geminate /tt/ may be represented as either (2a) or (2b). For convenience, I refer to the doubly linked structure of (2a) as a *true geminate* and the purely sequential

representation of (2b) as a *fake geminate*:

(2) a. *True Geminates* b. *Fake Geminates*

C C	C C
V	
t	t t

An assumption of the theory is that the distribution of true and fake geminates is largely predictable, as follows. First, geminates occurring within a single morpheme are represented as true geminates. This is required by the Obligatory Contour Principle (OCP); see the work of McCarthy (1981b; 1986), who argues convincingly that the OCP holds true for melodic representations within morphemes. Second, across morpheme boundaries fake geminates normally occur, since each morpheme provides both a melodic segment and a C slot from its lexical representation. Some languages, however (e.g. Tiberian Hebrew, McCarthy (1981a)), level out the distinction, converting fake geminates into true geminates by rule. It is only in languages that retain the distinction that the relevant tests can be made.

Observe now that if assimilation is spreading, then the output of a total assimilation rule must be a true geminate, as shown in (3a). However, there is no logical reason why assimilation could not also be expressed as feature changing even in a CV theory. If this option is followed, we predict that the output of a total assimilation will be a fake geminate, as in (3b):

(3) a. *Assimilation as Spreading*

C C	C C
	\ /
n t	t

b. *Assimilation as Feature Changing*

C C	C C
n t	t t

Thus, if in a given language true and fake geminates behave differently in the phonology, it should be possible to determine whether a rule of total assimilation is due to spreading or to feature changing. Geminates resulting from spreading would act like true geminates, whereas geminates from feature changing would act like fake geminates.

Several tests of this sort exist. I will discuss two of them, which I have mnemonically dubbed the *Integrity test* and the *Inalterability test*.

1.1. Integrity

I define "Integrity" as the unexpected failure of epenthesis or metathesis rules to split up the halves of a geminate consonant or long vowel. The effect was first noted by

ger class of partial
iergoes spreading.
ry (see Goldsmith
and Schein (forth-
he field is arguably
are.

stions that arise in
idence to bear on
assimilation rules,
ba Batak, an Aus-
hat the Batak data
forthcoming), Hayes
: commonplace re-

re diagnostics that
cond, I will present
ll apply the theory
; of the analysis.

2), Steriade (1982),
provided a number
review two of these

onsonants and long
phonetic sequence.
. For convenience,
e purely sequential

Kenstowicz and Pyle (1973). I follow here the discussion in Steriade (1982), applying it to an example from Palestinian Arabic (Abu-Salim (1980)). In this language certain consonant clusters are broken up by a rule of Epenthesis:

(4) *Palestinian Epenthesis*

$$\emptyset \rightarrow V / C \text{ --- } C \left\{ \begin{array}{l} C \\ \# \end{array} \right\}$$

|
i

The rule applies quite generally, but it is unexpectedly blocked when it would split a true geminate. For example, the true geminate in the monomorphemic form *sitt* 'grandmother' is unsplittable; thus, /sitt/ cannot become *[siti] through Epenthesis. In contrast, the fake geminates that arise across morpheme boundaries do permit splitting by Epenthesis: for example, *futit* from underlying /fut + t/ 'entered-lp. sg.'

As Jonathan Kaye originally pointed out (personal communication, cited in Halle and Vergnaud (1982)), CV theory predicts exactly this distinction. Epenthesis must insert both a V position and its associated /i/ melody. If the V position is in the middle of a true geminate, then the /i/ melody cannot be accommodated without violating the universally valid restriction on crossing association lines:¹

$$(5) \quad CC \quad *CVC, *CVC$$

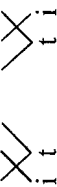
V → 

In a fake geminate the ban on crossing association lines does not block Epenthesis:

$$(6) \quad C \quad C \quad CVC$$

| + | → | | |
t t t i t

This basic contrast, which forms a fundamental argument for CV theory, is found in a number of languages; see the references cited in Hayes (1986).

Consider now how Integrity can be used to determine the mechanism of assimilation. Like most Arabic dialects, Palestinian Arabic has a rule that assimilates the /l/ of the definite article completely to any following coronal consonant. The geminates that result cannot be split by Epenthesis, even if the requirements for Epenthesis are otherwise met (Abu-Salim (1980, 9–10)). This argues that they are true geminates and that /l/-Assimilation is carried out by spreading. The derivation below illustrates this

¹ The blockage of Epenthesis under (4) also requires that the melodies for vowels and consonants appear on the same tier, even though they occupy separate tiers in the morphological component of Arabic. For arguments that vowel and consonant tiers are "amalgamated" in the phonology, see McCarthy (1986), Younes (forthcoming).

(82), applying it to a language like Toba Batak, we might get the following results:

schematically:

$$(7) \begin{array}{c} C & C \\ | & | \\ + & \\ \hline \\ I & t \end{array} \xrightarrow{\text{ll-Assimilation}} \begin{array}{c} C & C \\ \vee \\ t \end{array} \xrightarrow{\text{Epenthesis}} \begin{array}{c} *C & V & C, & *C & V & C \\ & X & & X & & \\ & i & t & i & t & i \end{array}$$

In other languages in which the Integrity test can be applied, the same result is obtained; see Hayes (1986) for references.

1.2. Inalterability

A second diagnostic for distinguishing true and fake geminates is based on what I have called 'Inalterability': the failure of segments forming halves of geminates to undergo rules they would a priori be expected to undergo. The standard example here is from Tigrinya (Schein (1981), Kenstowicz (1982)). In this language velar stops become spirants after a vowel, in alternations like *kʌlbi-ʔaxalib* 'dog-dogs'. But when a velar stop forms the first half of a true geminate, Spirantization fails to apply: for example, *fʌkkʌrʌ* 'he boasted'. The true geminates are 'Inalterable'; that is, they fail to undergo Spirantization even though they appear to meet the structural description of the rule. As Schein and Kenstowicz note, Inalterability is characteristic only of *true* geminate /kk/. Fake geminates, which result from the concatenation of /k/-final and /k/-initial morphemes, do permit the spirantization of their first element: for example, /mirak-ka/ → *miraxka* 'calf-2 m. sg.'

Kenstowicz and Schein point out that under the CV framework, it is straightforward to write a rule that will properly distinguish the two cases; one merely stipulates that only *singly linked* /k/ may undergo the rule. Their rule, with schematic derivations, is as follows:

(8) Tigrinya Spirantization

$$\begin{array}{c} V & C & \star \\ | & | & / \\ k \rightarrow x / & \vee & \end{array}$$

where \star indicates no association

a. *True Geminate* /kk/ (within morphemes)

$$\begin{array}{c} V & C & C \\ | & \vee & \\ a & & k \end{array} \rightarrow \text{not applicable}$$

b. *Fake Geminate* /kk/ (across morpheme boundaries)

$$\begin{array}{c} V & C & C & V & C & C \\ | & | & + & | & | & + & | \\ a & k & & k & a & x & k \end{array}$$

theory, is found

in a number of languages. For example, the /l/ of the geminate *ll* in *llin* 'in' is a true geminate that undergoes spirantization to /ɬ/. This illustrates this

theory, is found in a number of languages. For example, the /l/ of the geminate *ll* in *llin* 'in' is a true geminate that undergoes spirantization to /ɬ/. This illustrates this

The Inalterability facts of Tigrinya give rise to a second diagnostic for the mechanism of assimilation. Among the cases cited by Schein and Kenstowicz is *yikkafat* 'open-passive-jussive' from /yi-t-kafat/, where the /kk/ from assimilation does not spirantize. The following derivation illustrates why this is so. The total assimilation of /t/, when expressed as spreading, creates an Inalterable true geminate:

(9) */kk/ from Assimilation*

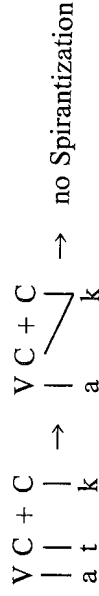

1.3. *Predictable Inalterability*

Subsequent research (Steriade (1982), Steriade and Schein (forthcoming), Hayes (1986)) has turned up numerous cases of Inalterability. In fact, the phenomenon appears to be so widespread that it would miss the point to adjust individual rules so that they will not affect true geminates, as Schein and Kenstowicz did for Tigrinya. Rather, we should try to locate a general principle that would predict Inalterability automatically for all rules that display it. Steriade and Schein (forthcoming) and Hayes (1986) both represent attempts in this direction. I will review my own proposal here, since it will be invoked in the arguments later on. However, the arguments would hold under Steriade and Schein's theory as well.

I will illustrate my proposal with the rule of Tigrinya Spirantization just discussed. My claim is that the rule should be formulated to apply to any /k/ linked to a C position, as in (10):

(10) *Tigrinya Spirantization (simplified)*

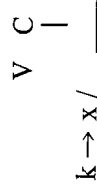

The fact that Spirantization is not applicable to true geminate /kk/ should be attributed to a general convention. In particular, if a rule R contains an autosegment A to which association lines are attached (e.g. C or /k/ in the Spirantization rule), then R may only apply to forms in which the autosegment corresponding to A bears exactly the same number of associations that A does. In other words, any association lines in a rule must match up exactly in order for the rule to apply to a form. Spirantization may apply to singly linked /k/ (as in (8b)) but not to doubly linked /k/ (as in (8a) and (9)), because its structural description specifies only one association line linked to /k/.

In Hayes (1986) I term this condition the *Linking Constraint*, stating it as follows:

(11) *Linking Constraint*

Association lines in structural descriptions are interpreted as exhaustive.

the mechanism
y#kkafat 'open-
not spirantize.
on of /t/, when

The Linking Constraint appears to be valid across languages: whenever a rule must contain association lines in its structural description for independent reasons, then that rule is found to affect only those forms in which the association lines match up exactly.

Crucially, the Linking Constraint is not a blanket prohibition on the application of rules to doubly linked structures. In particular, if a rule contains *no association lines at all*, because it applies on just one tier, then the Linking Constraint will not affect it. This appears to be correct; single-tier rules typically escape Inalterability. The Linking Constraint is thus "rule-relativized"; it determines the set of forms to which particular rules that contain association lines are applicable. We will see that the facts of Toba Batak support this approach.

The Linking Constraint provides a general diagnostic for the mechanism of assimilation. If a rule of total assimilation is due to spreading, the geminates it creates should be true geminates and will be Inalterable in the same contexts in which underlying true geminates are. Applying this diagnostic across languages (Hayes (1986)) again leads to the conclusion that the mechanism of total assimilation is spreading.

To summarize: the phenomena of Integrity and Inalterability strongly support the claim that total assimilation is spreading. They also provide clear tests for any theory that proposes to use spreading to handle partial assimilation as well. We should find that clusters derived by partial assimilation are subject to Integrity and obey the Linking Constraint.

2. Partial Assimilation in Autosegmental Phonology

In this section I argue for a particular theory of partial assimilation, to be assumed in the analysis of Toba Batak that follows.

2.1. Sources of Evidence

An autosegmental theory of partial assimilation is answerable to three kinds of data: facts about phonological rules, facts about phonetic representation, and facts about underlying representation.

First, the theory must have sufficient power to express all phonological assimilation rules. Since many different groups of features are involved in assimilation, the theory must therefore posit phonological representations that include a large number of autosegmental tiers, at least at some stage of the derivation. In other words, for every rule that assimilates a subset of the feature inventory, the theory must provide a tier that permits autosegmental spreading of just that subset of features.

Much research must be done to determine just which set of tiers will be required. In principle, however, this aspect of fully autosegmental theory should have explanatory value. Clements (1985) points out that the subsets of features involved in assimilation are not arbitrary; rather, the same subsets are found in language after language, and numerous logically possible subsets are never found. For example, assimilation involving all the place-of-articulation features is very common, but assimilation in the feature set

, Hayes (1986))
appears to be
that they will
her, we should
atically for all
both represent
will be invoked
r Steriade and
just discussed.
to a C position,

ld be attributed
ent A to which
ien R may only
actly the same
s in a rule must
n may apply to
9)), because its

g it as follows:

exhaustive.

[anterior, sonorant] would hardly be expected. Similarly, in Ancient Greek the features controlling the larynx assimilate together (Steriade (1982)), but assimilation in the feature set [round, spread glottis] is never found. There is nothing in the *SPE* phonological framework that predicts facts of this sort. By developing an explicit theory of multiple tiers, it should be possible to delimit the class of possible assimilation rules, thus increasing the predictive power of phonological theory.

Goldsmith (1976) points out a second source of evidence for fully autosegmental theory: multiple tiers are needed to provide a realistic view of phonetic representation. In actual speech production the articulators flail about in considerable dyssynchrony, and their actions are not easily describable as a linear sequence of phonetic segments. It is unlikely that an unbiased observer would imagine that the phonetic events of human languages encode a sequence of discrete units. The dyssynchrony of articulations suggests a fully autosegmental surface representation, perhaps with a single tier assigned to each articulator. As is expected in autosegmental representations, the transitions between the autosegments would be misaligned at the surface level, owing to the effects of deletion and reassociation rules.

Recent research has brought autosegmental phonetics beyond the programmatic stage outlined here. Keating (1985) presents a number of cases in which differences in the autosegmental surface representation are directly paralleled by patterns of coarticulation found in the acoustic record. It appears that coarticulation data may potentially serve as direct evidence for the form of surface representation.

The remaining evidence to constrain a theory of multiple tiers concerns underlying representation. A tier is arguably separate at the underlying level if the lexical entries for morphemes may be defined on it. Thus, in tone languages certain tonal melodies may carry grammatical meaning (Leben (1973), Goldsmith (1976), Pulleyblank (1982)). Similarly, in Semitic languages the CV tier and the melodic tier form domains on which morphemes may be defined (McCarthy (1979; 1981b)). In light of this, it is striking that the subtiers of the melody needed for expressing partial assimilation appear not to have morphemes defined on them. Insofar as morphemes exist in underlying representation, and insofar as morphemes can be defined on individual tiers, it would appear that the subtiers of the melody are not linguistic units at the underlying level.

Other sources of evidence lead to the same negative conclusion. For example, although rules of one-to-one, left-to-right "mapping" may be defined between the tonal tier and the CV tier and between the full melodic tier and the CV tier (Leben (1973), Goldsmith (1976), McCarthy (1981b)), the subtiers of the melody are not involved in mapping processes. Certain language games (Kenstowicz and Kisseberth (1979), Lehiste (1985), Odden (forthcoming)) have been adduced as evidence for the separate existence of the melodic, CV, and tonal tiers: in such cases the segments of one tier undergo movement, leaving the segments of the other tiers in place. Cases in which elements of the subtiers undergo movement appear to be lacking. Here again, the kinds of evidence that lead us to posit separate tiers in underlying representation fail to support the separate existence of subtiers at that level.

seek the features in the feature PE phonological theory of multiple in rules, thus in- y autosegmental c representation. e dyssynchrony, onetic segments. events of human articulations sug- iple tier assigned s, the transitions ing to the effects he programmatic ch differences in atterns of coarti- a may potentially icerns underlying he lexical entries nal melodies may ank (1982)). Simi- omains on which it is striking that ppear not to have ig representation, d appear that the

2.2. Basic Approaches

The evidence thus presents a conflict: the melodic tier must be divided into multiple subtiers at the surface and during the phonological derivation, but it appears to consist of unitary elements in underlying forms. This conflict can be resolved in at least two ways.

Clements (1985) presents an interesting proposal in which the melodic tier is not a sequence of feature bundles, but rather a sequence of trees. The terminal nodes of each tree dominate a subset of the features, forming subordinated subtiers. The tree formalism allows both the complete melody and its subtiers to be accessed at all levels of the derivation. However, in Clements's theory the subtiers are not actually independent tiers, but only constituents of the full melody. Hence, they cannot define morphemes, undergo mapping, or undergo movement independently of the melody as a whole.

An alternative to Clements's theory would be a theory of *tier decomposition*, adumbrated in Goldsmith (1976). Such a theory posits only a limited number of tiers in underlying representation, including a CV tier, a unitary melodic tier, and for some languages a tonal tier. The appearance of multiple tiers on the surface is due to rules of tier decomposition, which split up the melody and thus gradually expand the number of tiers up to the maximum found in phonetic representation. In the process of decomposition the phonology temporarily realigns the emerging autosegments. The more noticeable of these realignments are what phonologists write as assimilation rules.

In this article I adopt the approach of tier decomposition. The choice is somewhat arbitrary, since my theoretical results could also be obtained under Clements's theory. However, a slight advantage available under decomposition theory is presented below.

2.3. The Mode of Decomposition

Under an ideal theory of tier decomposition, the way in which the melody is dissected would not be stipulated in the phonology of individual languages, but would be determined by Universal Grammar. One aspect of the process seems clear a priori: decomposition cannot take place all at once. At intermediate stages of the derivation there must be tiers that encompass only a subset of the full melody, but are larger than the very detailed tiers that control individual articulators in phonetic representation. The tier for place of articulation is a good example: it is obviously phonologically relevant, but it controls several articulators at once.

Beyond this, it will clearly require an extensive research program to determine the nature of tier decomposition. Here I will deal only with that portion of decomposition that is required by the facts of Toba Batak to be analyzed below.

In Toba Batak the phonological derivation initially must split the melodic tier into two subtiers. One subtier, which I will call the *Peripheral tier*, contains the features responsible for the velum and the larynx: [nasal], [voice], [constricted glottis], and [spread glottis]. The other subtier, which I will call the *Central tier*, contains the remaining features, responsible for place and manner of articulation. Such a division be-

For example, al- between the tonal er (Leben (1973), e not involved in th (1979), Lehiste eparate existence one tier undergo which elements of kinds of evidence pport the separate

tween peripheral and central articulators may initially seem counterintuitive, but it is apparently attested in other languages.

Consider an example from English. In many dialects words like *dense*, *prince*, and *dance* optionally receive an epenthetic '[t]'; that is, the relevant words might be transcribed with [nts]. However, the process cannot be expressed as the insertion of a [t] segment, because the inserted "[t]" is phonetically shorter than the true /t/ found in *dents*, *prints*, and *plants* (Fourakis (1980)). CV phonology provides a straightforward account, one that follows a traditional view of phoneticians on the matter (see Jespersen (1904), Heffer (1960)): the "insertion of [t]" is actually the intrusion of the voicelessness and orality of the following /s/ into the closure for /n/. A typical derivation would be as in (12):

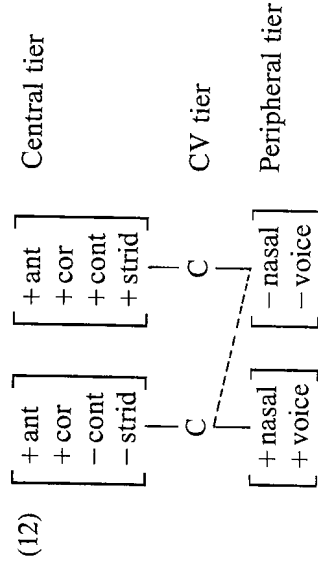

The shortness of the inserted '[t]' follows from its having to share a C slot with the partially dislodged /n/ melody on the Peripheral tier. Note that the alternative of spreading the noncontinuity of /n/ rightward onto the /s/ is excluded by parallel examples at other places of articulation: for example, /ms/ → [mps] in *Chomsky*, /ŋs/ → [ŋks] in *youngster*.

It might be asked why the realignment rule must spread [-voice] as well as [-nasal], given that English already has a rule of regressive voicing assimilation in obstruent clusters. The reason is that even those speakers who lack such a rule (saying, for example, [widθ] for *width*) still have a voiceless closure in *dense*, *prince*, etc. Apparently, nasality and voicing must spread together on a single Peripheral tier.

An additional example supporting the Central/Peripheral tier distinction may be found in the South American language Maxakali; for discussion, see Anderson (1974, 267-273; 1976).

2.4. The Geometry of Autosegmental Representations

A further issue that a theory of tier decomposition must face is how the numerous tiers that appear on the surface in a decomposed representation are linked up to each other. The facts of Toba Batak reveal little concerning this issue; see Pulleyblank (1982), Archangeli (1985), Clements (1985) for useful discussion and proposals. To keep the representations straightforward, I will assume that the subtiers of Batak are all linked directly to the CV tier; however, other configurations would also be compatible with the data.

intuitive, but it is
lense, prince, and
 rds might be tran-
 : insertion of a [t]
 : true /t/ found in
 a straightforward
 ter (see Jespersen
 the voicelessness
 ation would be as

2.5. *Phonetic Features and Cover Features*

The remaining issue I will discuss involves a crucial difference in status among the phonological features. Vennemann and Ladefoged (1973) point out that some features, such as [nasal], [back], and [spread glottis], are directly interpretable as articulatory gestures. Other features, however, are more 'logical' or 'classificatory' in nature. A good example is [sonorant]. This feature is obviously phonologically relevant, but it has no direct articulatory interpretation. A segment may be made [+sonorant] in two distinct ways: by providing sufficient aperture at the point of articulation, or by lowering the velum to produce a nasal. In Vennemann and Ladefoged's theory [sonorant] would be a 'cover feature'; it classifies segments in a phonologically relevant way, but is implemented indirectly by other, truly phonetic features.

To integrate cover features into fully autosegmental phonology will require further research. Here I will make a fairly minimal assumption: that throughout the derivation the cover feature [sonorant] is adjusted automatically to conform to the phonetic feature values that manifest it. In particular, I adopt the following convention:

(13) *[Sonorant]-[Nasal] Convention*

Any segment made [+nasal] by rule is automatically marked as [+sonorant].

This convention will be crucial in the analysis of Toba Batak.

2.6. *Summary*

The autosegmental model of partial assimilation I am assuming can be summarized as follows. Underlying representations contain the CV tier, the melodic tier, and any relevant prosodic tiers, such as the tonal tier. The phonological derivation decomposes the melodic tier into subtiers, roughly along articulatory lines. At various stages of the derivation assimilation rules may delete or realign the autosegments. The outputs of these rules are immediately adjusted by conventions such as (13), which define the 'cover' features. Surface representations are fully autosegmentalized and serve as the input for articulatory control.

3. *Consonant Sandhi in Toba Batak*

I will now present an analysis of Toba Batak consonant sandhi using the theory just proposed.

3.1. *Data*

The variety of Toba Batak described here is spoken by my consultant Wilson Manik, who comes from Samosir. Manik's dialect has the following inventory of consonant phonemes:

a C slot with the
 native of spreading
 examples at other
 pks] in *youngster*.
 s well as [-nasal],
 ation in obstruent
 le (saying, for ex-
 , etc. Apparently,
 istinction may be
 : Anderson (1974,

he numerous tiers
 up to each other.
 ulleyblank (1982),
 sals. To keep the
 atak are all linked
 e compatible with

(14)

	Bilabial	Alveolar	Palato-Alveolar	Velar	Glottal
Voiceless stops	p	t		k	
Voiced stops	b	d		g	
Voiced affricate			ʃ		
Voiceless continuants		s			h
Nasals	m	n		ŋ	
Liquids		r, l			

The phonemic status of [h] is unclear. Morpheme-finally, [h] does not occur in underlying representations, but serves as an allophone of /k/. When a vowel follows, /k/ is converted to [h] by the following rule:

- (15) /k/-Weakening
 k → h / ____ (#) V

/k/-Weakening is quite productive and results in numerous alternations such as *halak* 'person' ~ *halah i* 'the person'. However, a number of borrowed words, such as *kɔrɛa* 'Korea', *kalabbu* 'mosquito net', show /k/ before a vowel within the same morpheme. These instances of /k/ are somewhat unstable and are sometimes regularized to /h/. Nonetheless, I will assume that /h/ is a phoneme of Toba Batak and that /k/-Weakening applies only in "derived environments" (Kiparsky (1973)). Hence, *halak* is phonemically /halak/. Nothing crucial depends on this decision.

A glottal stop (ʔ) also occurs in Batak, but it is clearly not an independent phoneme: [ʔ] everywhere derives from /p/, /t/, or /k/ before a consonant, by the rule of Glottal Formation stated below.

The rules of consonant sandhi apply to a large variety of clusters. However, because of limitations on the underlying distribution of consonants, only a subset of the logically possible inputs to sandhi actually arises. In particular, Toba Batak syllables take the form (C)V(C), so that clusters are limited to two consonants. Further, /h/ does not occur morpheme-finally or syllable-finally in underlying representation. The voiced obstruents do not occur morpheme-finally in underlying forms either; and they may appear syllable-finally only when they form the first half of a tautomorphemic geminate.

The basic data are presented in table 1, which should be interpreted as follows. When underlying C₁ (row headings) is followed by C₂ (column headings), the sequence is usually altered as shown in the chart. The changes shown occur both within words and across word boundaries. Optional variants are separated by commas. Note that because of the restrictions on underlying representations just noted, the chart exhausts the logical possibilities.

The boxes in the chart enclose the sets of clusters that may be altered by phonological rules in the analysis below. There are four boxes that include just one cluster. I will not formulate the minor rules that account for these changes, since they will have no bearing on the argument to be made.

Glottal

h

not occur in
wel follows,

ich as *halak*
uch as *korɛa*
: morpheme.
urized to /h/.
/-Weakening
homonemically

nt phoneme:
le of Glottal

ver, because
'the logically
bles take the
es not occur
ad obstruents
ear syllable-

d as follows.
the sequence
within words
is. Note that
part exhausts

ed by phono-
one cluster. I
ney will have

Table 1
Consonant sandhi in Toba Batak

		C ₂ : p t k h s b d j g m n r l												
C ₁ :		/n/-Assimilation												
		p	t	k	pp,	tt,	ss,	ss	ʔp	ʔt	ʔk	ʔp,	ʔt	ʔk
p		ʔp	ʔt	ʔk	pp,	ʔh	ʔs	ʔb	ʔd	ʔj	ʔg	ʔm	ʔn	ʔr
t		ʔp	ʔt	ʔk	tt,	ʔh	ʔs, ss	ʔb	ʔd	ʔj	ʔg	ʔm	ʔn	ʔr
k		ʔp	ʔt	ʔk	kk,	ʔh	ʔs	ʔb	ʔd	ʔj	ʔg	ʔm	ʔn	ʔr
s		sp	sk	ss	ss	ss	ss	sb	sd	sj	sg	sm	sn	sr
m		pp	pk	pp	ps, ss	ss	ss	bb	md	mj	mg	mm	mn	mr
n		pp	tt	kk	kk	ss	ss	bb	dd	jj	gg	mm	nn	rr
ŋ		kp	kt	kk	kk	ks	ks	ŋb	ŋd	ŋj	ŋg	ŋm	ŋn	ŋr
r		rp	rt	rk	rh	rs	rs	rb	rd	rj	rg	rm	rn	rr
l		lp	lt	lk	lh	ls	ls	lb	ld	lj	lg	lm	ln	lr

Glottal
Formation

The four major rules illustrated in the chart may all be suppressed in slow, careful speech, but they apply regularly at normal speaking rates. For clarity, I will first present the rules in linear notation.

The rule of /n/-Assimilation completely assimilates /n/ to a following consonant:

(16) /n/-Assimilation

- | | | |
|----|-------------------|----------------------------------|
| n | C | |
| 1 | 2 | → 2 2 |
| a. | manjan baa an | (cf. <i>manjan</i> in isolation) |
| | [b b] | |
| | eat man that | 'that man is eating' |
| b. | baoa an peddek | |
| | [p p] | |
| | man that short | 'that man is short' |
| c. | lean lali | |
| | [l l] | |
| | give hen-harrier | 'give a hen-harrier' |
| d. | sojon gottina | |
| | [g g] | |
| | as replacement | 'in exchange' |
| e. | manjan halak i | |
| | [k k] [h] | |
| | eating person the | 'the person is eating' |

The aberrant case /nh/ → [kk] clearly reflects the historical origin of [h] as /k/. This could be analyzed by phonemizing *halak* as /kalak/ and marking "genuine /k/" words such as *kreka* as exceptions to /k/-Weakening. Alternatively, we could postulate a patch-up rule taking /h/ to /k/ after /n/. Either alternative suffices for our purposes.

The rule of Denasalization converts nasals to voiceless stops before voiceless consonants. In linear notation it appears as follows:

(17) Denasalization

- $$\left[\begin{array}{c} C \\ +nasal \end{array} \right] \rightarrow \left[\begin{array}{c} -nasal \\ -voice \end{array} \right] / \text{---} \left[\begin{array}{c} C \\ -voice \end{array} \right]$$
- | | | |
|----|-----------------|-------------------|
| a. | manjunum tuak | |
| | [p t] | |
| | drink palm wine | 'drink palm wine' |
| b. | holom saetik | |
| | [p s] | |
| | dark somewhat | 'somewhat dark' |

1 slow, careful
ill first present

consonant:

- c. mananom pirin
[p p]
bury dish
'bury a dish'
- d. manan pulpen
[k p]
or pen
'or a pen'
- e. mamerɛŋ kalabbu
[k k]
look-at net
'look at a mosquito net'

The rule of /h/-Assimilation assimilates /h/ to a preceding obstruent. Such obstruents may include the voiceless stops derived by Denasalization, as in (18d-e):

(18) /h/-Assimilation

[-son] h
1 2 → 1 1

- a. marisap hita
[p p]
smoke we
'let us smoke'
- b. dohot halak
[t t]
and person
'and a person'
- c. manipak harajjan i
[k k]
kick basket the
'kick the basket'
(i.e. /mh/ → /ph/ → [pp])
- d. modom halak i
[p p] [h]
sleeping man the
'the man is sleeping'
(i.e. /ŋh/ → /kh/ → [kk])
- e. dibereŋ halak i horbo i
[k k] [h]
saw man the buffalo the
'the man saw the buffalo'

The final rule to be considered is Glottal Formation, which converts /p,t,k/ to [ʔ] when preconsonantal:

(19) Glottal Formation

$\left[\begin{array}{c} \text{-son} \\ \text{-cont} \end{array} \right] \rightarrow \text{ʔ} / \text{--- C}$

- a. ganup taon
[ʔ t]
every year
'every year'

- b. *dohot lali i*
[ʔ l] and hen-harrier the 'and the hen-harrier'
- c. *halak batak*
[ʔ b] person Batak 'Batak person'
- d. *lap pingol*
[ʔ p] wipe-off ear 'wipe off the ear'
- e. *manjihut taon*
[ʔ t] following year 'according to the year'
- f. *halak korea*
[ʔ k] person Korea 'Korean person'

Observe that Glottal Formation can reduce the identical clusters /pp,tt,kk/ to [ʔp,ʔt,ʔk].

At this point we arrive at the crux of the Batak problem: Glottal Formation is not surface true, but fails just in case the preconsonantal voiceless stop either derives from assimilation or has itself triggered assimilation. This can be seen in the examples (16b) *baoa an peddek* ([pp]), from /n/-Assimilation; (17d) *manay pulpen* ([kp]), from Denasalization; and (18b) *dohot halak* ([tt]), from /h/-Assimilation. One way to describe this would be to place Glottal Formation first in the rule ordering and have all the assimilation rules counterfeed it. This would yield the following derivations:

(20)	/pt	pp	np	np	mh	th/	Glottal Formation
	ʔt	ʔp	—	—	—	—	/n/-Assimilation
	—	—	pp	—	—	—	Denasalization
	—	—	—	kp	ph	—	/h/-Assimilation
	—	—	—	—	pp	tt	Output
	[ʔt	ʔp	pp	kp	pp	tt]	

There is a minor complication: /th/ might be expected to yield *[ʔʔ], which is impossible. Recall, however, that all of the rules are optional. Granting various assumptions about the relative speaking rates at which the rules apply, we can assume that [tt] results from suppressing Glottal Formation but not /h/-Assimilation. We can exclude *[ʔʔ] by stipulating that /ʔ/ cannot trigger /h/-Assimilation. The result of applying Glottal Formation but not /h/-Assimilation, namely [ʔh], is in fact occasionally heard.

3.2. An Autosegmental Analysis

An alternative account that the autosegmental framework suggests is as follows: the rules of /n/-Assimilation, Denasalization, and /h/-Assimilation apply first, producing melodic elements linked to two C positions. Glottal Formation is ordered last and is

blocked by the Linking Constraint (11) whenever an earlier assimilation has applied. Consider now a specific implementation of this scheme.

We begin with the necessary rule orderings. In any analysis /n/-Assimilation must precede Denasalization, so as not to be bled by it in cases like /np/ → [pp] (not *[tp]). Denasalization in turn must precede /h/-Assimilation, since the latter rule is triggered by obstruents, including obstruents created by Denasalization (for example, /mh/ → /ph/ → [pp]). Finally, the hypothesis we are testing requires that Glottal Formation be ordered last.

The next task is to determine a mode of tier decomposition consistent with the above orderings and the general principles of the theory. The earliest rule, /n/-Assimilation, is a total assimilation rule and is best expressed on a representation in which the melodic tier is intact. For the next rule, Denasalization, I assume the proposal made earlier: the nasal and laryngeal features are split off into a separate Peripheral tier, and the remaining features form the Central tier. This arrangement of tiers also suffices for an adequate statement of /h/-Assimilation and Glottal Formation, as I will show. Further tier divisions would be reflected in the phonetic detail rules of the language.

Note that the required rule orderings are what one would expect under the theory: earlier rules invoke less-decomposed representations. Whether this can be maintained as a general principle remains to be determined.

We can now specify the rules of Batak autosegmentally in their proper order. /n/-Assimilation appears as in (21):

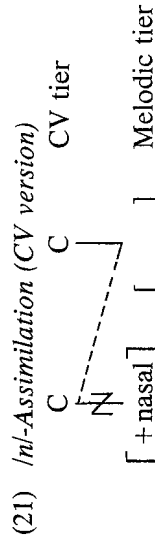

That is, a C position linked to melodic /n/ is reassociated with the melody of an immediately following consonant. I assume that when this happens, the displaced /n/ melody is deleted by convention. The rule derives [tt] from /nt/ as follows:

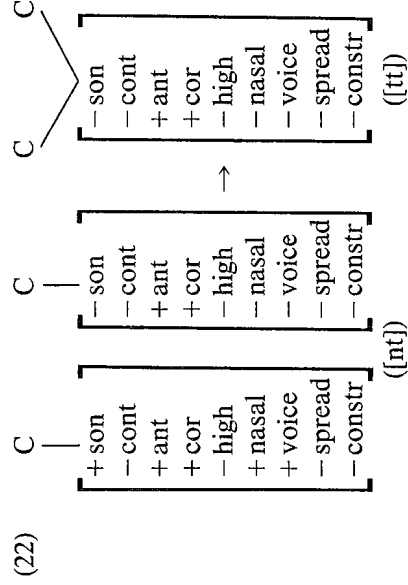

ak/ to [ʔp, ʔt, ʔk].
 formation is not
 er derives from
 examples (16b)
 , from Denasali-
 to describe this
 the assimilation

ʔ], which is im-
 us assumptions
 e that [tt] results
 xclude *[ʔʔ] by
 ing Glottal For-
 urd.

as follows: the
 first, producing
 lered last and is

At this point in the derivation the Peripheral tier, containing the feature [nasal] plus the laryngeal features, is split off from the melody, leaving the remaining features behind as the Central tier. The Peripheral tier allows Denasalization to be stated as follows:

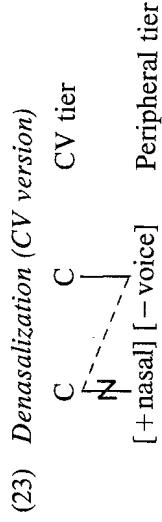

The rule states that a Peripheral autosegment that includes [-voice] should spread leftward to displace a Peripheral autosegment that includes [+nasal]. Denasalization applies to /tp/ as in (24):

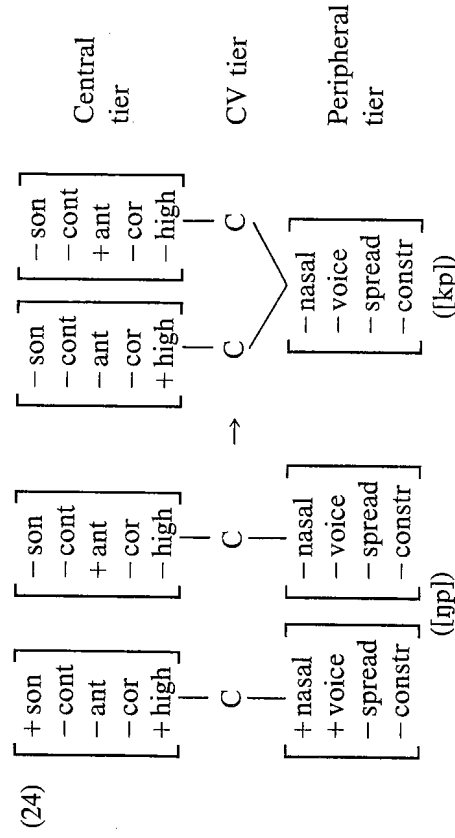

Observe that when the segment /t/ is rendered [-nasal], the [Sonorant]-[Nasal] Convention (13) marks it as [-sonorant] as well; denasalized noncontinuant are necessarily obstruents.

The rule of /h/-Assimilation can also be expressed as spreading. Note that /h/ has no inherent Central feature specifications; in all languages it acquires these specifications through spreading (Lass (1976), Goldsmith (1979; 1981)). What makes Batak special is that the source of the spreading can be a consonant rather than a vowel:

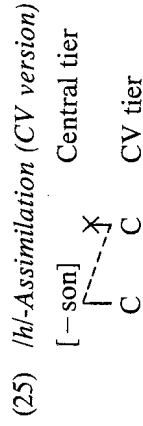

A simple case of /h/-Assimilation, /th/ → [tt], is shown below:

ure [nasal] plus features behind d as follows:

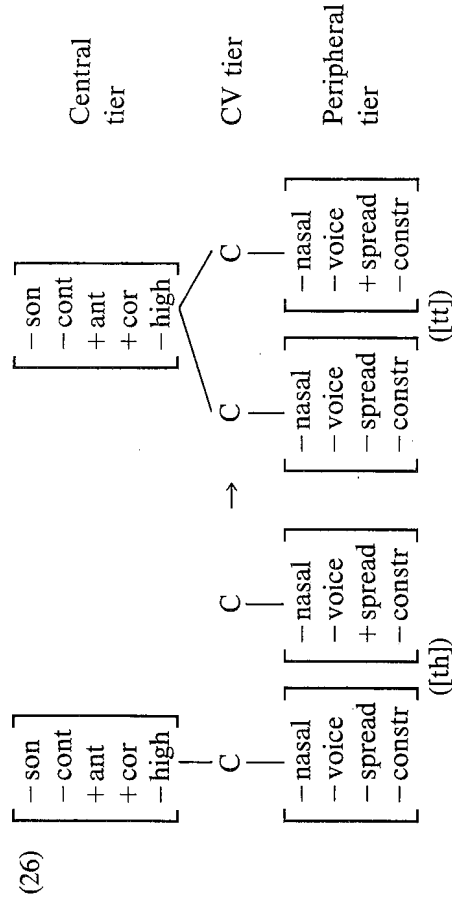

ould spread left-alization applies

Those instances of /h/ that survive /h/-Assimilation ultimately acquire Central features by spreading from an adjacent vowel, via the following rule:

(27) *Glottal Consonant Specification*



Note that /h/-Assimilation is expressed as a partial assimilation; the Peripheral auto-segment of the /h/ remains intact. There is empirical support for this claim. A minority of instances of /pp,tt,kk/ derived from /h/-Assimilation are phonetically [pp^h,tt^h,kk^h], with aspiration on the second member of the cluster. The aspiration is weak, involving about 15–20 msec voice onset time rather than the 40–80 msec found for English, but it is faintly audible.

To check up on my ears, I did an experiment comparing voice onset time for a matched population of [pp,tt,kk] derived from /ph,th,kh/ and from other sources. Enough instances of [pp,tt,kk] from underlying /ph,th,kh/ surfaced with weak aspiration to produce a statistically significant difference in voice onset time between the two groups; $t_{10} = 2.348, p < .05$.

A phonological account of my observations would be as follows. The Batak weak aspirates involve the occasional failure of a stop articulation to persist long enough to cover up (and thus render inaudible) the [+spread glottis] autosegment of /h/ on the Peripheral tier. I assume that ordinary voiceless stops in Batak are inherently [-spread glottis] and thus will not be aspirated even if their supraglottal articulations terminate prematurely. The true aspirates of English derive from phonological spreading of [+spread glottis] onto the following vowel, which makes them clearly audible. Although the details of this proposal are conjectural, the basic argument seems clear: /h/-Assimilation cannot be total assimilation, because if it were, the geminates it derives would always be identical to the other geminates of Batak.

nt]-[Nasal] Con-
s are necessarily

Note that /h/ has
se specifications
Batak special is
el:

The derivation of [pp] from /mh/ (likewise [kk] from /qhd/) involves three stages. First, Denasalization spreads the Peripheral melody of /h/ leftward onto /m/. Next, the denasalized /m/ is rendered [-sonorant]-[Nasal] Convention. Third, /h/-Assimilation spreads the Central melody of the former /m/ onto /h/, with the output [pp] resulting:

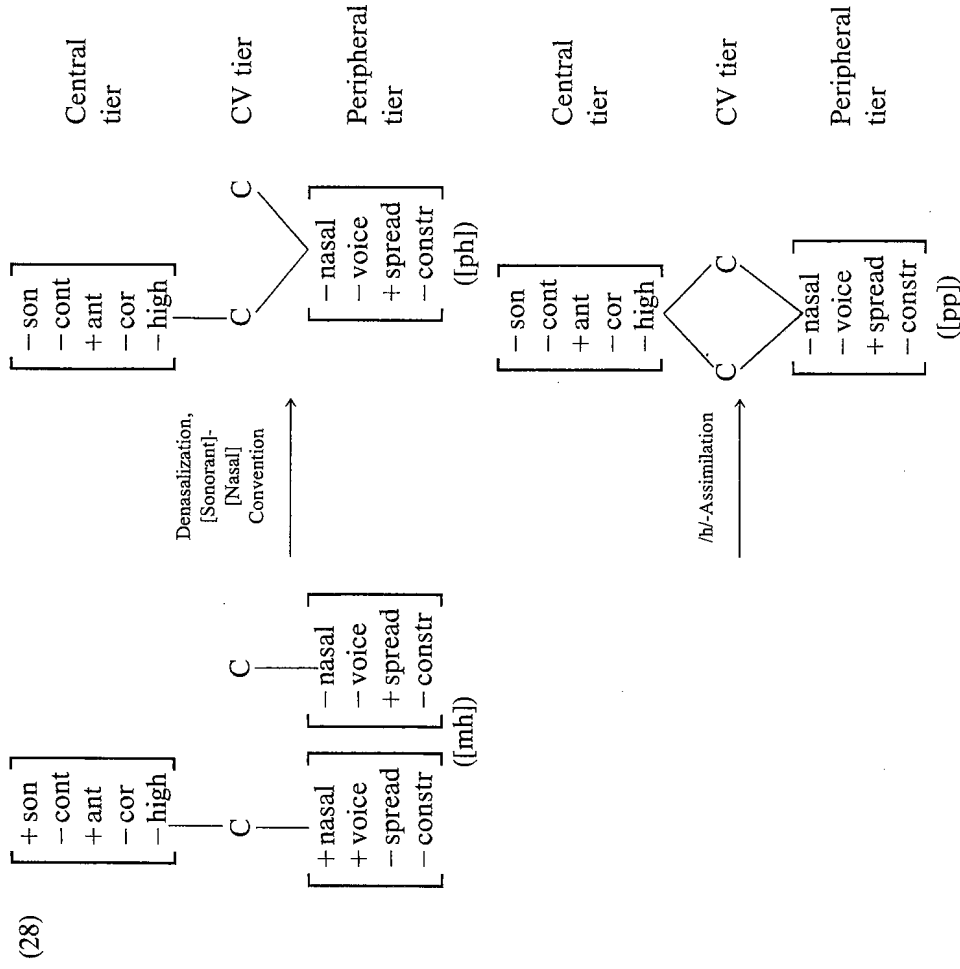

This derivation illustrates why the Linking Constraint is formulated to be “relativized” to particular rules, rather than marking all doubly linked structures as immune to rule application. The /ph/ derived from /mh/ is a doubly linked structure, but the linking occurs on a tier that is not mentioned by /h/-Assimilation. Accordingly, /h/-Assimilation is not blocked by the Linking Constraint.

Consider now the rule of Glottal Formation. I would claim that, by the assumptions made so far, this rule must be tri-tieral: it mentions the Central tier to identify voiceless

three stages.
m/. Next, the
ation. Third,
ith the output

stops with [-sonorant, -continuant]; it mentions the CV tier to identify preconsonantal position; and it mentions the Peripheral tier to specify the output as [+constricted glottis], the identifying feature of [ʔ]. The full rule is stated as follows:

(29) *Glottal Formation (CV version)*

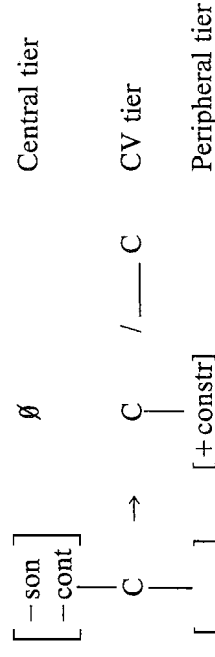

CV tier

Two aspects of this rule require comment. Note first that Glottal Formation deletes the Central features of the former voiceless stop. I assume that [ʔ] later acquires Central features from the preceding vowel via the same process that supplies Central features to /h/. We can do this by generalizing the rule of Glottal Consonant Specification (27) to apply in mirror image fashion, leftward first. Note also that Glottal Formation includes an unspecified Peripheral autosegment to the left of the arrow. This serves to indicate that the rule converts the existing Peripheral autosegment to [+constricted glottis], rather than inserting an entirely new autosegment.

Glottal Formation would apply to fake geminate /tʔ/ as follows:

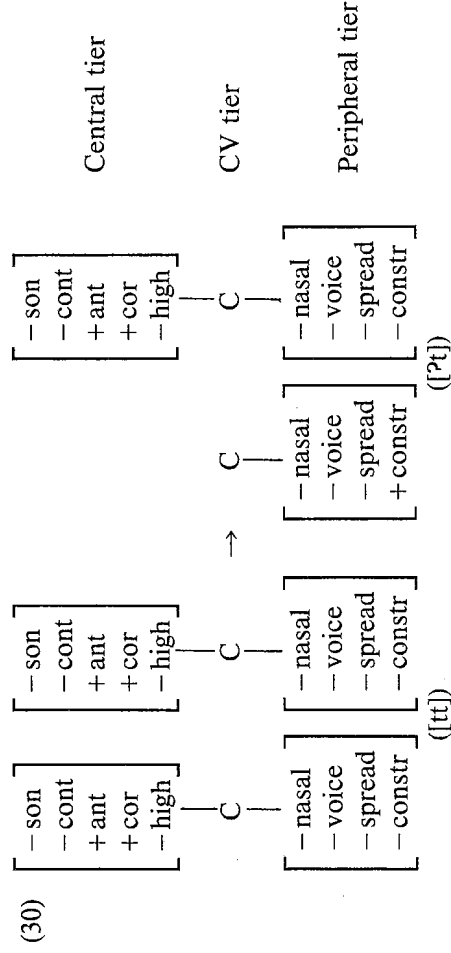

l to be "relativ-
s as immune to
, but the linking
/h/-Assimilation

With all four rules reformulated, we reach the crucial part of the analysis. The Linking Constraint predicts that whenever one of the three assimilation rules has applied (that is, /m/-Assimilation (21), Denasalization (23), or /h/-Assimilation (25)), then the double linkage that results should block Glottal Formation. There are four cases to be considered.

the assumptions
identify voiceless

Case 1. /h/-Assimilation creates structures such as that shown under (26) (repeated

as (31a) for /th/ → [tt]. Here the autosegment for the Central tier bears a double linkage. In the formulation of Glottal Formation the autosegment on the Central tier is only singly linked. By the Linking Constraint, Glottal Formation cannot be matched up to the doubly linked structure, and [tt] survives on the surface. The relevant structures are shown below with the mismatched elements circled:

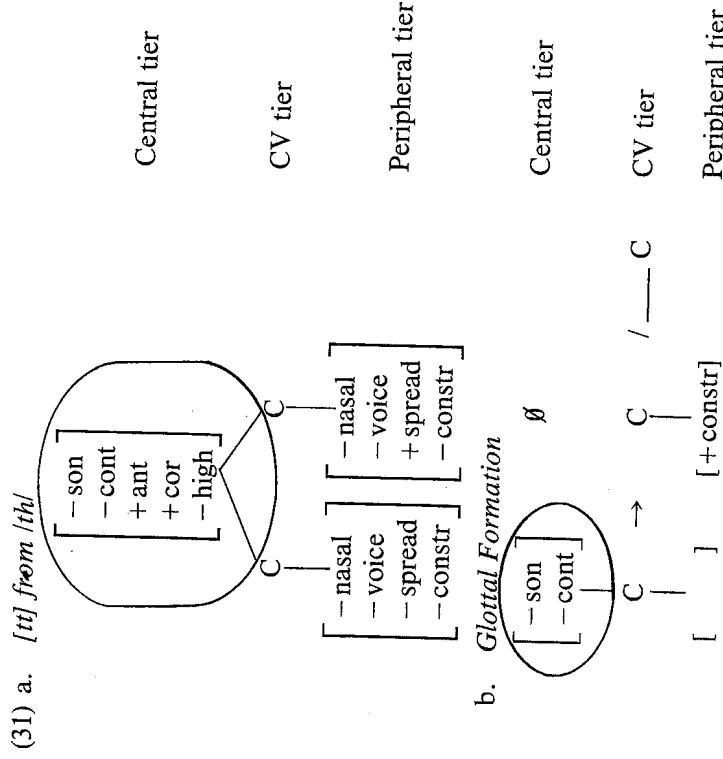

Note that if /h/-Assimilation is not applied (it is optional), then Glottal Formation should not be blocked, so that the output would be [ʰ]. As noted above, this is a possible pronunciation.

Case 2. In examples like /ŋp/ → [kp], under (24), Denasalization creates structures in which a single autosegment on the Peripheral tier is linked to two C positions. Since the Peripheral tier autosegment in the structural description of Glottal Formation is singly linked, the Linking Constraint blocks application.

Case 3. In examples like /mh/ → [pp], under (28), Denasalization and /h/-Assimilation have created doubly linked autosegments on both the Peripheral and the Central tiers. Glottal Formation is doubly blocked by the Linking Constraint.

Case 4. When /n/-Assimilation converts /nt/ to /tt/, as in (22), spreading applies on the full, undivided melodic tier. The resulting single /t/ autosegment is later divided “vertically” in the splitting off of the Peripheral tier. The resulting output, shown under (32), will not be eligible for Glottal Formation, for the same reason as in case 3.

a double linkage. tier is only singly d up to the doubly ctures are shown

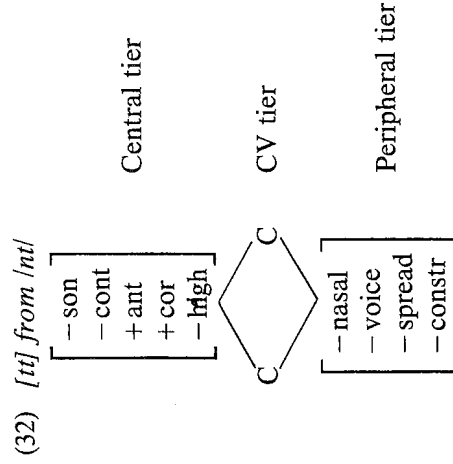

To summarize this discussion: the autosegmental theory outlined above permits a straightforward account of Toba Batak consonant sandhi. By invoking the Linking Constraint, the analysis captures the generalization that Glottal Formation fails to apply to segments that have either undergone or triggered assimilation. The analysis suggests that for purposes of the Linking Constraint, partial assimilation behaves in the same way as total assimilation.

3.3. Consonant Sandhi within Words

I argued earlier that autosegmental accounts of assimilation are preferable to feature-changing accounts on grounds of their inherently greater restrictiveness. In this section I will show that the autosegmental spreading analysis is superior to feature changing on empirical grounds as well.

The analysis of the preceding section, which was based solely on sandhi across word boundaries, extends straightforwardly to word-internal consonant alternations. Since the sandhi rules are optional, for most words it is straightforward to determine the underlying representation. For example, it is clear that the alternating segment in the following words must be represented as underlying /ŋ/:

- (33) aŋsa ~ aksa 'goose'
 masiŋsiŋ ~ masiksiŋ 'to drive'
 hasuŋsuŋ ~ hasuksuŋ 'restless'

The variant with surface /k/ is derived by Denasalization. Similarly, the alternating form *huphup* ~ *huppup* 'norms' should be represented underlyingly as /huphup/, with the variant [huppup] derived by /h/-Assimilation.

Another class of words contains a stem-internal voiceless stop occurring in free variation with [ʔ]:

Glottal Formation
 e, this is a possible
 creates structures
 C positions. Since
 formation is singly
 id /h/-Assimilation
 the Central tiers.

reading applies on
 nt is later divided
 tput, shown under
 is in case 3.

- (34) a. *saptu* ~ *saʔtu* 'Saturday'
taptap ~ *taʔtap* 'to slap'
ruprap ~ *ruʔrap* 'to trample'
 b. *rɔtrɔt* ~ *rɔʔrɔt* 'to knock down'
pitpit ~ *piʔpit* 'with closed eyes'
metmet ~ *mɛʔmet* 'small'
 c. *paksa* ~ *paʔsa* 'to force'
ŋekŋus ~ *ŋɛʔŋus* 'incompetent person'
diktator ~ *diʔtator* 'dictator'

Given the optional rule of Glottal Formation, the underlying representations for these words clearly should be /saptu/, /rɔtrɔt/, /rɔtrɔt/, /paksɑ/, and similarly for the other examples. These forms show that Glottal Formation can apply morpheme-internally.

Given this, it is a striking fact that morpheme-internal geminate stops in Toba Batak do not alternate; that is, morpheme-internal /pp,tt,kk/ cannot be pronounced [ʔp, ʔt, ʔk]. The following words illustrate this:

- (35) a. *pinɔppar* 'descendent'
lɔppa 'cook'
panippanan 'storage'
oppuŋ 'grandfather'
 c. *dɛkke* 'fish'
nakkin 'just now'
rukkuf 'neck'
sukkup 'adequate'
- b. *pamarettta* 'parliament'
pittu 'door'
attitj 'earring'
attuk 'to hit'

The invariance of these forms is predicted by the theory assumed here. By the Obligatory Contour Principle, nonalternating /pp,tt,kk/ within a single morpheme must form true geminates in underlying representation. Their phonological derivations will be straightforward. The only change they undergo prior to Glottal Formation is tier splitting, as shown in (36) for /tt/:

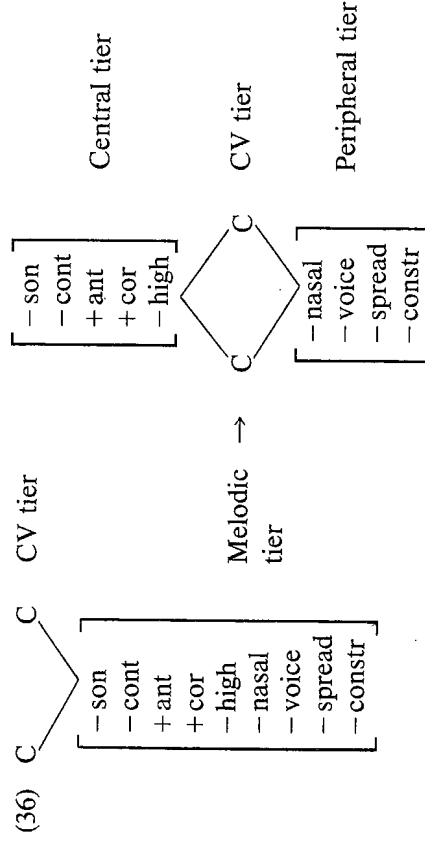

As before, the Linking Constraint will prevent Glottal Formation from applying to these forms.

Toba Batak geminates thus display the expected pattern for Inalterability: they are immune to Glottal Formation just in case they are tautomorphic or they derive from assimilation. This is precisely the set of facts that serves to diagnose assimilation as spreading.

At this point we can consider how the above facts might be handled within a linear framework. The linear model can account for consonant sandhi across boundaries by invoking counterfeeding rule order (see (20)). However, this makes the clear prediction that tautomorphic geminates found in underlying representation should undergo Glottal Formation. This is incorrect, as the data of (35) show. One might try to salvage the situation by adding extra stipulations to the linear Glottal Formation rule, as in (37):

(37) *Glottal Formation (revised)*

$$\left[\begin{array}{c} \text{-son} \\ \text{-cont} \end{array} \right]_i \rightarrow ? / \text{---} \langle \# \rangle C_j$$

Condition: If $i = j$, then # must be present.

But even this fairly complex rule is observationally inadequate. Glottal Formation *can* apply to word-internal geminates, provided they are created by morpheme concatenation and are thus fake:

- (38) a. /adat-ta/ → ada?ta 'our custom'
 custom-1 pl.
 b. /suddut-ta/ → suddu?ta 'our generation'
 generation-1 pl.

The linear rule must therefore be stated as in (39):

(39) *Glottal Formation (revised)*

$$\left[\begin{array}{c} \text{-son} \\ \text{-cont} \end{array} \right]_i \rightarrow ? / \text{---} \left\langle \left\{ \begin{array}{c} \# \\ + \end{array} \right\} \right\rangle C_j$$

Condition: If $i = j$, then $\left\{ \begin{array}{c} \# \\ + \end{array} \right\}$ must be present.

Rule (39) is to be faulted both for its complexity and, more important, for its failure to *explain* the data. The class of geminates to which Glottal Formation applies is stipulated arbitrarily under the linear analysis but is to be expected a priori under the autosegmental analysis.

3.4. *The History of the Batak Rules*

This section discusses the historical development of the Toba Batak consonant sandhi system. I will show that the historical data provide further evidence against a linear

tations for these other examples. illy.

ops in Toba Batak ounced [ʔp, ʔt, ʔk].

'parliament'
 'door'
 'carring'
 'to hit'

med here. By the le morpheme must derivations will be tion is tier splitting,

tier

ral tier

analysis for Batak. In addition, the historical facts provide evidence concerning the proper formulation of the Obligatory Contour Principle.

3.4.1. Further Evidence against a Linear Analysis. Information is available concerning three earlier stages of Toba Batak. For convenience I summarize this in table 2. The four dialects listed in the table can give us a rough idea of the evolution of the Batak rules.

The rules of /n/-Assimilation, Denasalization, and /h/-Assimilation appear in all four systems, although in slightly different form (van der Tuuk (1971, 10–14), Nababan (1981, 58–60), Percival (1981, 28–37)). Glottal Formation, however, varies considerably across descriptions, in a way that suggests that it is a new rule. The earliest author, van der Tuuk, does not mention Glottal Formation in Toba Batak or any other Batak dialect he describes.² Nababan does describe a rule of Glottal Formation in his speech. Interestingly, his rule is restricted in scope: it affects /p,t,k/ only before voiced consonants—precisely the environment where it would not interact with the other rules. The dialect described by Percival contains a Glottal Formation rule identical to the one described here. Thus, Nababan's dialect plausibly represents a transitional stage between the van der Tuuk dialect, with no rule, and the other dialects, with complete Glottal Formation.

A caveat: each of the four descriptions is based on the speech of a different location. My argument is tentative in the absence of detailed work on Batak dialects: Nevertheless, the overall pattern of the data suggests that Glottal Formation is an innovating rule, having generalized from the embryonic form found in Nababan's dialect to the full version found in Percival (1964) and the present work.

Table 2
Sources of historical data for Toba Batak

Reference	Source of Data
van der Tuuk (1864; English translation 1971)	Field work done in 1850s
Nababan (1966; revised 1981)	Speech of author, born 1922
Percival (1964; revised 1981)	Informant work 1957–1960; consultants were students at Yale University
Present study	Wilson Manik, born 1953

² This is unlikely to be a random omission: van der Tuuk is otherwise quite explicit on the phonetics and phonology of the language. In an excursus (1971, 70) he describes a rule similar to Glottal Formation in the related language Menangkabau.

concerning the
 ble concerning
 in table 2. The
 n of the Batak
 appear in all four
 Nababan (1981,
 iderably across
 uthor, van der
 atak dialect he
 eech. Interest-
 1 consonants—
 les. The dialect
 : one described
 etween the van
 ttal Formation.
 ferent location.
 : Nevertheless,
 novating rule,
 the full version

This in itself is evidence against the linear analysis. In general, it has been found that new rules enter a phonology late in the ordering, preceding only low-level phonetic rules (King (1973)). This is exactly what is predicted by the autosegmental analysis, which claims that Glottal Formation is ordered after all the other rules. In contrast, the linear account is in an awkward position: it must claim that Glottal Formation entered the phonology not only in nonfinal position, but fully four rules deep into the ordering. The alternative that Glottal Formation entered the phonology at the surface and was then reordered also seems unlikely: the putative reordering creates a great deal of opacity (Kiparsky (1971)), for it switches Glottal Formation from feeding to counterfeeding order with respect to all three assimilation rules. Furthermore, rule reorderings normally leave behind relic forms, which reveal where the reordered rule once applied in morpheme-internal environments (Kiparsky (1968; 1973)). Such forms, which in Batak would contain morpheme-internal [ʔ, ʔt, ʔk] from historical /pp,tt,kk/, are totally unattested. In summary, the linear analysis appears to be inconsistent with the available historical evidence concerning the Toba Batak rule system.

3.4.2. *Restructuring and the OCP.* The evolution of the Batak rules is significant from another perspective, involving the proper formulation of the Obligatory Contour Principle (OCP). The crucial evidence is provided by certain words that Manik pronounces “unhistorically”; that is, his pronunciation is not what one would expect given the ancestral forms and the historical sound changes. The relevant words originally contained /ŋ/ followed by a heterorganic consonant, as in (40):

(40)	<i>Historical</i>	<i>Current</i>	
	<i>Pronunciation</i>	<i>Pronunciation</i>	
	saksaj	saksaj ~ saʔsaj	‘ceremonial dish’
	pekpeŋ	pekpeŋ ~ peʔpeŋ	‘midget’
	raŋsa	raksa ~ raʔsa	‘explanation’

From the history of Batak, one would expect these words to have the variants [saksaj] ~ [saksaj], [pekpeŋ] ~ [pekpeŋ], and [raŋsa] ~ [raksaj], by the rule of Denasalization. However, Manik rejects the pronunciations with [ŋ], giving instead the variants shown.³

What could explain these unhistorical pronunciations? My conjecture is that the changes in these words are the result of restructuring. Consider the evidence available to the learner of Batak in determining underlying representations. In cases of sandhi across boundaries the problem of learning underlying forms is trivial: the learner knows that surface [halaʔ batak] ‘Batak person’ is underlyingly /halak batak/ simply because *halak* ‘person’ is pronounced with a final /k/ in isolation. Similarly, the underlying /n/ of *pulpet-ta* (< /pulpen-ta/) ‘our pen’ is easily acquired from the isolation form *pulpen*.

³ A caveat: the judgments here are not too stable, since Manik is familiar with more conservative speech in which these forms have not shifted. It is apparently difficult to separate individual practice from community practice in this area. In other areas, where community pronunciation is more uniform, Manik’s judgments are more secure.

For clusters within morphemes, however, the underlying forms are not as accessible, owing to the opacity and optionality of the rules. For instance, a surface form [pekpeŋ] could be the result of applying Denasalization to /peŋpeŋ/, but it could also be simply underlying /pekpeŋ/, without application of Glottal Formation. A child who hears mostly *pekpeŋ*, and only rarely the careful variant *peŋpeŋ*, is liable to reinterpret *pekpeŋ* as an underlying form. This is restructuring, and it leads to drastic results: the former *peŋpeŋ* is now rejected as a possible pronunciation, and *peʔeŋ* becomes possible; it is the output of applying Glottal Formation to the new underlying form.⁴

There exists a second class of restructured words, exemplified below:

(41) <i>Historical Pronunciation</i>	<i>Current Pronunciation</i>	
punpun	puppun	'tie into a bouquet'
tintin	tittin	'ring'
sihunkun	sihukkun	'kind of bird'
lampu	lappu	'lamp'
tinta	titta	'ink'
banku	bakku	'bench'

The evidence for restructuring here is that the historical pronunciations (e.g. *[punpun]) are no longer possible. The present-day underlying forms must be /puppun/, /tittin/, etc., with underlying geminates. Now, unlike the restructured words noted under (40), the forms of (41) are unanimously ineligible to undergo Glottal Formation; that is, they can only be pronounced with [pp, tt, kk] and not with [ʔp, ʔt, ʔk]. We have already seen why this should be so. The morpheme-internal geminates in restructured /puppun/, /tittin/, /sihukkun/ must be true geminates, owing to the OCP, and are therefore immune to the effects of Glottal Formation.

The significance of these data is that they can provide us with a tool to investigate the nature of the OCP. As McCarthy (1986) states it, the OCP forbids sequences of identical melodic autosegments within the same morpheme in underlying representation. Suppose, contrary to the assumptions we have employed, that melodic subtiers do exist in underlying forms, rather than being derived by rule. This is in fact what is posited under the autosegmental "tree" theory of Clements (1985). Under such a theory, we might expect that the OCP would hold for subtiers as well as for the full melody; that is, the "savings" in feature specifications that the OCP makes available to the melody as a whole would be extended to instances in which only subtier segments were identical.

The Batak data show that such a version of the OCP is untenable. To see why,

⁴ A possible objection to this line of reasoning would be that the reduplicated structure of a CVC × 2 root would provide independent evidence that the underlying form should be /peŋpeŋ/, irrespective of the frequency of the surface variants. Against this can be noted two things. First, in almost all of the CVC × 2 roots of Batak the isolated element CVC doesn't mean anything. CVC × 2 reduplication is not a general rule of Batak morphology, but only a common root pattern. Second, Batak contains numerous CVCCVC roots that are not reduplications; in fact, these very much outnumber the reduplicated roots. There is nothing ill-formed about /pekpeŋ/ as an underlying representation.

not as accessible, the form [pekpeŋ] also be simply /ho hears mostly ret pekpeŋ as an e former peŋpeŋ e; it is the output

low:

s (e.g. *[punpun]) pun/, /tittin/, etc., d under (40), the ; that is, they can already seen why /puppun/, /tittin/, re immune to the

ool to investigate aids sequences of ng representation. e subtiers do exist ct what is posited such a theory, we ; full melody; that ble to the melody nts were identical. able. To see why,

structure of a CVC × 2 :p/, irrespective of the ost all of the CVC × 2 on is not a general rule erous CVCCVC roots is. There is nothing ill-

consider the restructuring whereby surface [pekpeŋ], from underlying /peŋpeŋ/, was reinterpreted as underlying /pekpeŋ/. If the OCP held of subtiers, then the new underlying form would have a doubly linked autosegment on the Peripheral tier, since /k/ and /p/ do not differ in their peripheral features:

(42) *Reanalysis of [kp] with OCP Applicable to Subtiers*

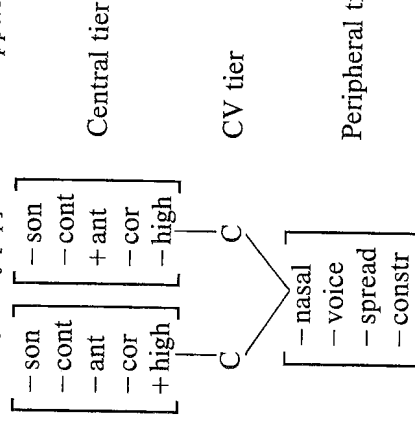

But this is precisely the structure that is found for [kp] derived from underlying /ŋp/. As we have already seen, this structure is immune to Glottal Formation. Since /kp/ from reanalysis does undergo Glottal Formation, (42) cannot be the correct underlying representation for reanalyzed /kp/.

Under the framework advocated here, this undesirable result would not arise. The OCP holds of underlying representations, hence only for intact melodic segments and not for subtiers. The structure assigned to [kp] when it is reinterpreted as an underlying form is therefore that of (43a). It undergoes the derivation shown to become [ʔp].

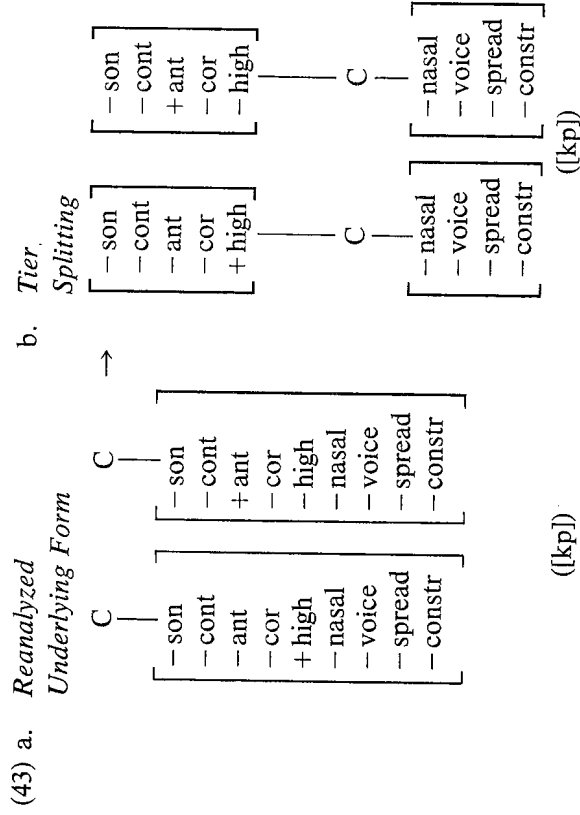

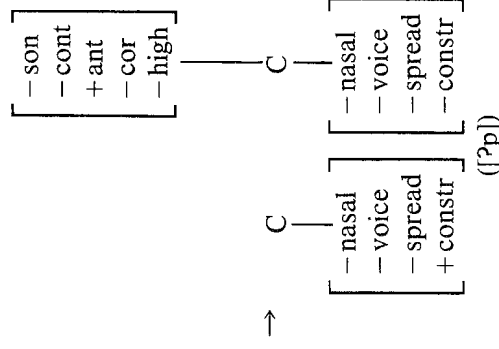
c. *Glottal Formation*

To summarize this discussion: reanalyzed clusters in Batak differ in their behavior depending on whether they are phonetic geminates or distinct sequences; only the latter undergo Glottal Formation. To explain this, we need to assume that the OCP holds in underlying representation for the full melodic tier, but not for the subtiers used in accounting for partial assimilation.

Indirectly, this result supports the theory of tier decomposition advocated by Goldsmith and adopted here. The reason is that if subtiers do not exist in underlying representation, then there can be no question of the OCP holding of them. The theory of Clements (1985), which posits multiple tiers at all levels, must make the arbitrary stipulation that the OCP holds only for the melodic tier taken as a whole, and not for its constituent subtiers. This does not rule Clements's theory out, but does diminish its attractiveness.

4. Summary

In this article I have analyzed the fairly complex segmental assimilations of Toba Batak within a fully autosegmental framework. The theoretical results of the analysis are as follows.

First, the autosegmental account seems clearly superior to alternative segmental treatments. The Glottal Formation rule must be made highly complex within the segmental theory, merely to encode distinctions that are made available automatically in autosegmental theory. In addition, the historical evolution of the system appears straightforward under the autosegmental approach, but is inexplicable in a linear framework.

Second, the analysis provides further empirical support for proposed constraints on the Inalterability of linked structures. The discussion invoked the Linking Constraint of Hayes (1986); however, the alternative proposal of Steriade and Schein (forthcoming)

would work just as well. The analysis suggests that the Linking Constraint (or equivalent) holds for the linkings created by partial assimilation as well as for full geminates.

Finally, the analysis argues for a particular version of the Obligatory Contour Principle: it should be formulated at underlying representation, to hold only of the full melodic tier.

References

- Abu-Salim, I. M. (1980) "Epenthesis and Geminate Consonants in Palestinian Arabic," *Studies in the Linguistic Sciences* 10.2, Department of Linguistics, University of Illinois, Urbana.
- Anderson, S. R. (1974) *The Organization of Phonology*, Academic Press, New York.
- Anderson, S. R. (1976) "Nasal Consonants and the Internal Organization of Segments," *Language* 52, 326-344.
- Archangeli, D. (1985) "Yokuts Harmony: Evidence for Coplanar Representation in Nonlinear Phonology," *Linguistic Inquiry* 16, 335-372.
- Chomsky, N. and M. Halle (1968) *The Sound Pattern of English*, Harper and Row, New York.
- Clements, G. N. (1985) "The Geometry of Phonological Features," *Phonology Yearbook* 2, 225-252.
- Clements, G. N. and S. J. Keyser (1983) *CV Phonology: A Generative Theory of the Syllable*, MIT Press, Cambridge, Massachusetts.
- Fourakis, M. (1980) "A Phonetic Study of Sonorant-Fricative Clusters in Two Dialects of English," in R. F. Port, ed., *Research in Phonetics, Report #1*, Department of Linguistics, Indiana University, Bloomington.
- Goldsmith, J. (1976) *Autosegmental Phonology*, Doctoral dissertation, MIT, Cambridge, Massachusetts. [Distributed by the Indiana University Linguistics Club, Bloomington.]
- Goldsmith, J. (1979) "The Aims of Autosegmental Phonology," in D. A. Dinnsen, ed., *Current Approaches to Phonological Theory*, Indiana University Press, Bloomington and London.
- Goldsmith, J. (1981) "Subsegmentals in Spanish Phonology: An Autosegmental Approach," in W. W. Cressey and D. J. Napoli, eds., *Linguistic Studies in the Romance Languages* 9, Georgetown University Press, Washington, D.C.
- Halle, M. and J.-R. Vergnaud (1980) "Three Dimensional Phonology," *Journal of Linguistic Research* 1, 83-105.
- Halle, M. and J.-R. Vergnaud (1982) "Metrical Structures in Phonology," ms., Department of Linguistics and Philosophy, MIT, Cambridge, Massachusetts.
- Hayes, B. (1986) "Inalterability in CV Phonology," *Language* 62.2.
- Heffer, R.-M. S. (1960) *General Phonetics*, University of Wisconsin Press, Madison.
- Jespersen, O. (1904) *Lehrbuch der Phonetik*, tr. by Hermann Davidsen, B. G. Teubner, Leipzig and Berlin.
- Keating, P. (1985) "CV Phonology, Experimental Phonetics, and Coarticulation," *UCLA Working Papers in Phonetics* 62, Department of Linguistics, UCLA, Los Angeles, California. [Also to appear in the proceedings of the 1985 "Colloque phonologie pluri-linéaire," Université Lyon 2.]
- Kenstowicz, M. J. (1982) "Geminataion and Spirantization in Tigrinya," *Studies in the Linguistic Sciences* 12.1, Department of Linguistics, University of Illinois, Urbana.
- Kenstowicz, M. J. and C. Kisseberth (1979) *Generative Phonology: Description and Theory*, Academic Press, New York.
- Kenstowicz, M. J. and C. Pyle (1973) "On the Phonological Integrity of Geminate Clusters," in

n their behavior
; only the latter
e OCP holds in
iers used in ac-

ocated by Gold-
underlying rep-
1. The theory of
ie arbitrary stip-
, and not for its
oes diminish its

is of Toba Batak
; analysis are as

ative segmental
: within the seg-
automatically in
appears straight-
ear framework.
ed constraints on
ing Constraint of
in (forthcoming)

- M. J. Kenstowicz and C. Kisseberth, eds., *Issues in Phonological Theory*, Mouton, The Hague.
- King, R. (1973) "Rule Insertion," *Language* 49, 551-578.
- Kiparsky, P. (1968) "Linguistic Universals and Linguistic Change," in E. Bach and R. Harms, eds., *Universals in Linguistic Theory*, Holt, Rinehart and Winston, New York.
- Kiparsky, P. (1971) "Historical Linguistics," in W. O. Dingwall, ed., *A Survey of Linguistic Science*, University of Maryland Press, College Park.
- Kiparsky, P. (1973) "Phonological Representations," in O. Fujimura, ed., *Three Dimensions in Linguistic Theory*, TEC Company, Tokyo.
- Lass, R. (1976) *English Phonology and Phonological Theory*, Cambridge University Press, Cambridge.
- Leben, W. (1973) *Suprasegmental Phonology*, Doctoral dissertation, MIT, Cambridge, Massachusetts. [Published 1979 by Garland Press, New York.]
- Lehiste, I. (1985) "An Estonian Word Game and the Phonematic Status of Long Vowels," *Linguistic Inquiry* 16, 490-492.
- McCarthy, J. J. (1979) *Formal Problems in Semitic Phonology and Morphology*, Doctoral dissertation, MIT, Cambridge, Massachusetts. [Distributed by the Indiana University Linguistics Club, Bloomington.]
- McCarthy, J. J. (1981a) "The Representation of Consonant Length in Hebrew," *Linguistic Inquiry* 12, 322-327.
- McCarthy, J. J. (1981b) "A Prosodic Theory of Nonconcatenative Morphology," *Linguistic Inquiry* 12, 373-418.
- McCarthy, J. J. (1986) "OCP Effects: Geminata and Antigeminata," *Linguistic Inquiry* 17, 207-263.
- Nababan, P. W. J. (1966) *Toba Batak, a Grammatical Description*, Doctoral dissertation, Cornell University, Ithaca, New York.
- Nababan, P. W. J. (1981) *A Grammar of Toba Batak*, Pacific Linguistics, Series D, No. 37, Australian National University, Canberra.
- Odden, D. (forthcoming) "A CV Analysis of Vowel Length in Kimatumbi," ms., Ohio State University, Columbus.
- Percival, W. K. (1964) *A Grammar of Toba Batak*, Doctoral dissertation, Yale University, New Haven, Connecticut.
- Percival, W. K. (1981) *A Grammar of the Urbanised Toba-Batak of Medan*, Pacific Linguistics, Series B, No. 76, Australian National University, Canberra.
- Pulleyblank, D. (1982) *Tone in Lexical Phonology*, Doctoral dissertation, MIT, Cambridge, Massachusetts.
- Schein, B. (1981) "Spirantization in Tigrinya," in H. Borer and J. Aoun, eds., *MIT Working Papers in Linguistics* 3, Department of Linguistics and Philosophy, MIT, Cambridge, Massachusetts.
- Steriade, D. (1982) *Greek Prosodies and the Nature of Syllabification*, Doctoral dissertation, MIT, Cambridge, Massachusetts.
- Steriade, D. and B. Schein (forthcoming) "On Geminates," to appear in *Linguistic Inquiry*.
- Tuller, L. (1984) "Linking Effects in Hausa," ms., Department of Linguistics, UCLA, Los Angeles, California.
- van der Tuuk, H. N. (1864) *Tobasche Spraakkunst, Eerste Stuuk: Klankstelsel*, Frederik Muller, Amsterdam.
- van der Tuuk, H. N. (1971) *A Grammar of Toba Batak*, tr. by Jeune Scott-Kemball, Martinus Nijhoff, The Hague.

theory, Mouton, The
 Bach and R. Harms,
*Survey of Linguistic
 Three Dimensions in
 e University Press,
 Cambridge, Massa-
 Long Vowels," Lin-
 ology, Doctoral dis-
 iana University Lin-
 ," *Linguistic Inquiry*
 ology," *Linguistic In-
 inquistic Inquiry* 17,
 dissertation, Cornell
 s, Series D, No. 37,
 bi," ms., Ohio State
 ale University, New
 i, Pacific Linguistics,
 n, MIT, Cambridge,
 , eds., *MIT Working
 y, MIT, Cambridge,
 eral dissertation, MIT,
 inquistic Inquiry.
 tics, UCLA, Los An-
 lsel, Frederik Muller,
 ott-Kemball, Martinus**

Vennemann, T. and P. Ladefoged (1973) "Phonetic Features and Phonological Features," *Lingua* 32, 61-74.

Younes, R. (forthcoming) "The Representation of Geminate Consonants," ms., Department of Linguistics, University of Texas, Austin.

Department of Linguistics
2113 Campbell Hall
UCLA
Los Angeles, California 90024